

NUTSTOßEN & VERZÄHNUNG
BROACHING & GEAR CUTTING



www.gisstec.com

Klemmhalter zum Nutstoßen
Keyway Broaching Holders

5



Nutstoßplatten
Broaching Inserts

6



Nutstoßplatten aus Hartmetall
Carbide Broaching Inserts

10



Stoßwerkzeuge Vierkant
Square Broaching Tools

14

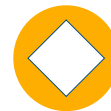

Stoßwerkzeuge Sechskant
Hexagon Broaching Tools

15

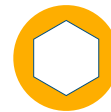

Verzahnungswerkzeuge
Spline Broaching Tools

16



Zubehör
Accessories

18



Nutstoßgerät
Live Broaching Unit

22



Klemmhalter für Nutstoßgeräte
Holders for Live Broaching Tools

24



Nutstoßwerkzeugset
Broaching Tool Kit

30



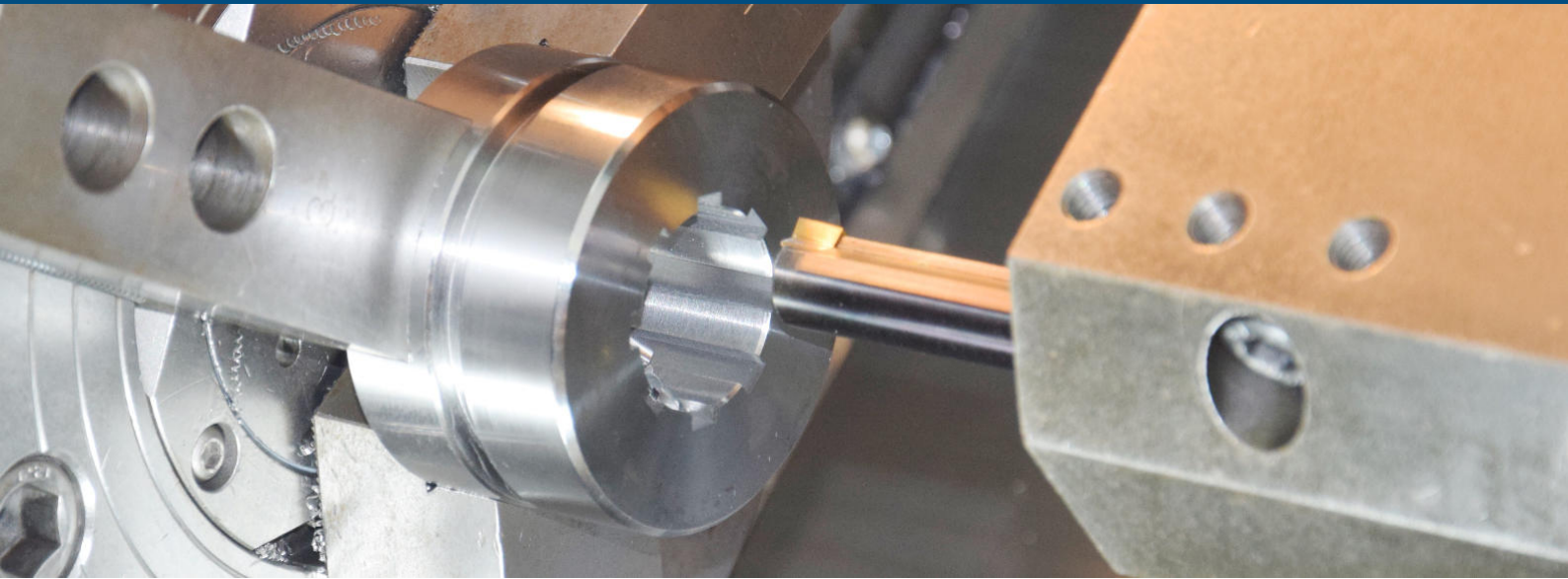

Nutstoßwerkzeuge

- ✓ Ideale Lösung für Nutstoßen auf Bearbeitungszentren und Drehmaschinen
- ✓ Klemmhalter aus gehärtetem Werkzeugstahl
- ✓ Plattensitz gehärtet: 58-60 HRC
- ✓ Ø3,5 Bohrungen für Kühlmittelzuführung
- ✓ Sonderwerkzeuge auf Anfrage

Broaching Tools

- ✓ Ideal solution for slotting on CNC Lathes and Milling Machines
- ✓ Tool holders made of hardened tool steel
- ✓ The seat of the insert is hardened at 58-60 HRC
- ✓ Ø3.5 mm coolant holes
- ✓ Fast delivery for special tools upon request

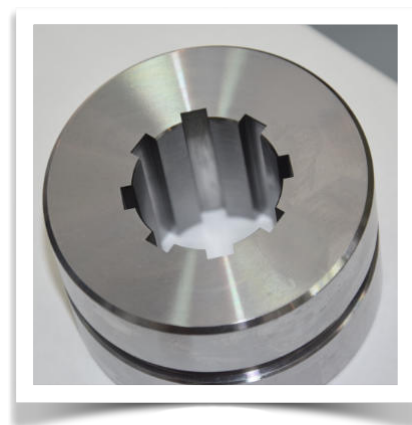
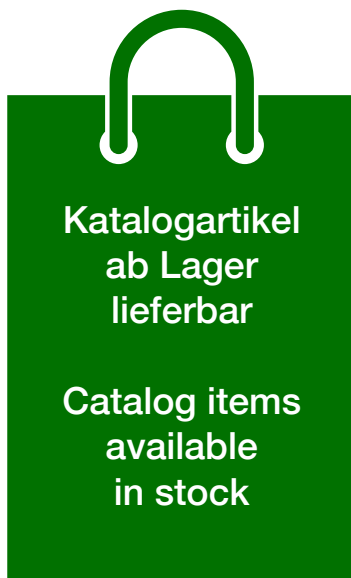

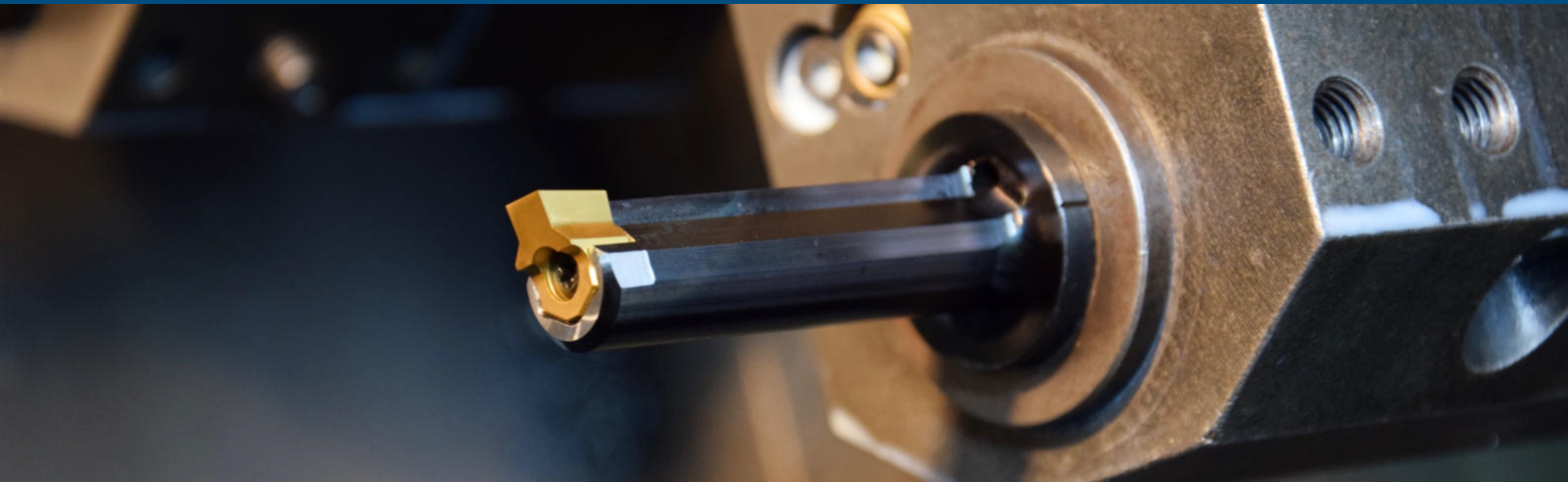

Nutstoßplatten

- ✓ In zwei Materialien erhältlich
- ✓ Gesinterte HSS-Legierung mit Cobalt oder Hartmetall
- ✓ Härte: 72 HRC
- ✓ TIN beschichtet
- ✓ Mehrmaliges Nachschleifen möglich
- ✓ Sonderplatten kurzfristig lieferbar

Broaching Inserts

- ✓ Available in two materials:
- ✓ Sintered HSS alloy with cobalt or Carbide
- ✓ Hardness: 72 HRC
- ✓ TIN coating
- ✓ Can be sharpened several times
- ✓ Fast delivery for special inserts

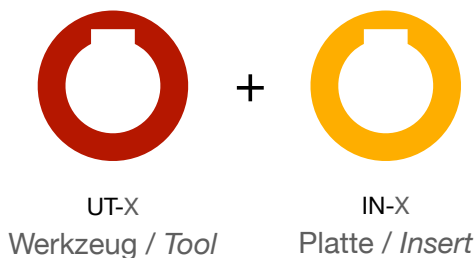

X: Nutenbreite / Slot width

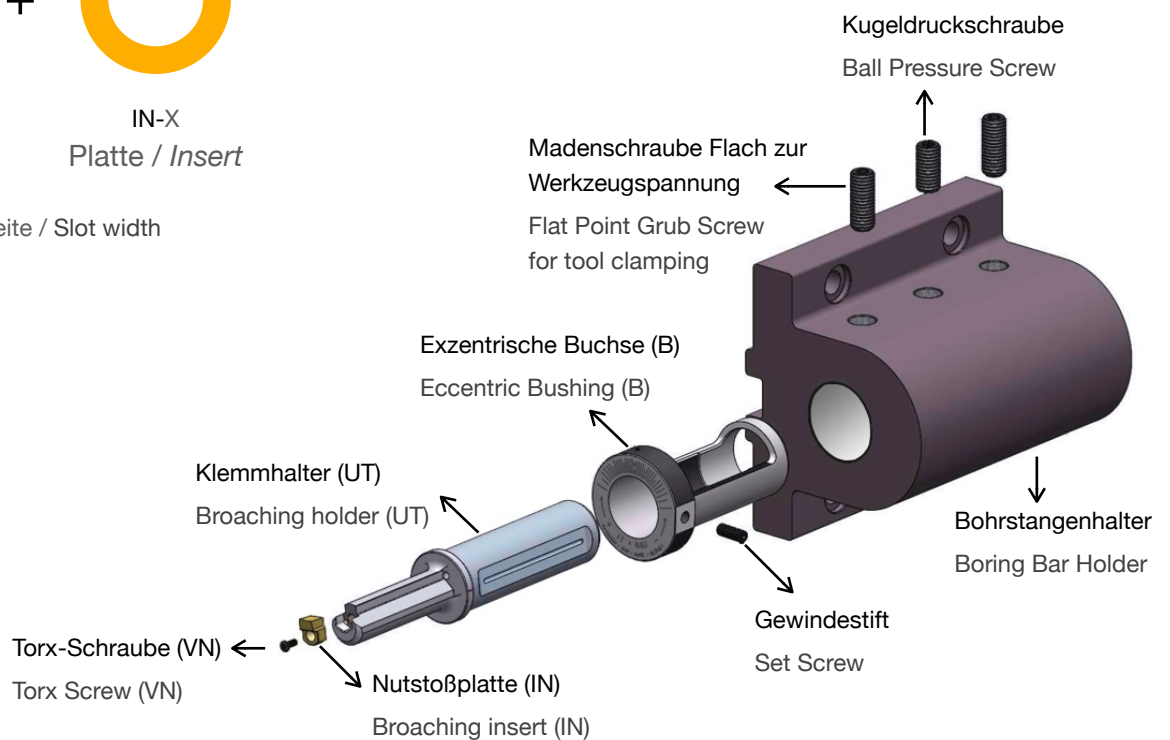



2 - 25 mm
3/32" - 3/4"

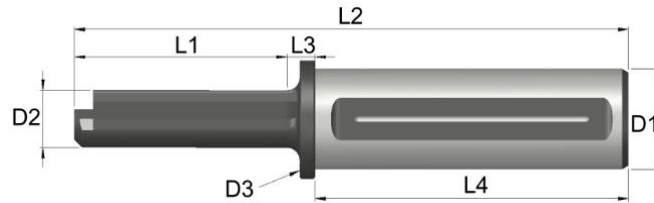

Längsnut
Keyway

Halter Holder	L1 mm	L2 mm	L3 mm	L4 mm	D1 mm	D2 mm	D3 mm	PN	T	VN	Min Ø mm
UT-02-25	25	124	9	90	25	6	30	PN-1	T08	VN-1	7
UT-02-25-L	34,5	133,5	9	90	25	6	30	PN-1	T08	VN-1	7
UT-03-25	30	129	9	90	25	8	30	PN-1	T08	VN-1	8,7
UT-03-25-L	40	139	9	90	25	8	30	PN-1	T08	VN-1	8,7
UT-04-25	40	139	9	90	25	10	30	PN-1	T08	VN-1	11
UT-04-25-L	56	155	9	90	25	10	30	PN-1	T08	VN-1	11
UT-05-25	46	145	9	90	25	12	30	PN-1	T08	VN-1	13
UT-05-25-L	66	165	9	90	25	12	30	PN-1	T08	VN-1	13
UT-06-25	56	155	9	90	25	16	30	PN-2	T15	VN-2	17,5
UT-06-25-L	81	180	9	90	25	16	30	PN-2	T15	VN-2	17,5
UT-08-25	68	167	9	90	25	20	30	PN-2	T15	VN-2	21,5
UT-08-25-L	100	199	9	90	25	20	30	PN-2	T15	VN-2	21,5
UT-10-25	86	185	9	90	25	25	30	PN-3	T20	VN-3	28
UT-10-25-L	126	225	9	90	25	25	30	PN-3	T20	VN-3	28
UT-12-25	104	203	9	90	25	30	30	PN-3	T20	VN-3	32
UT-12-25-L	161	260	9	90	25	30	30	PN-3	T20	VN-3	32
UT-14/16-25	126	221	5	90	25	35	37	PN-4	T20	VN-3	37
UT-14/16-25-L	180	285	5	100	35	25	37	PN-4	T20	VN-3	37
UT-02-32	25	134	9	100	32	6	37	PN-1	T08	VN-1	7
UT-02-32-L	34,5	143,5	9	100	32	6	37	PN-1	T08	VN-1	7
UT-03-32	30	139	9	100	32	8	37	PN-1	T08	VN-1	8,7
UT-03-32-L	40	149	9	100	32	8	37	PN-1	T08	VN-1	8,7
UT-04-32	40	149	9	100	32	10	37	PN-1	T08	VN-1	11
UT-04-32-L	56	165	9	100	32	10	37	PN-1	T08	VN-1	11
UT-05-32	46	155	9	100	32	12	37	PN-1	T08	VN-1	13
UT-05-32-L	66	175	9	100	32	12	37	PN-1	T08	VN-1	13
UT-06-32	56	165	9	100	32	16	37	PN-2	T15	VN-2	17,5
UT-06-32-L	81	190	9	100	32	16	37	PN-2	T15	VN-2	17,5
UT-08-32	68	177	9	100	32	20	37	PN-2	T15	VN-2	21,5
UT-08-32-L	100	209	9	100	32	20	37	PN-2	T15	VN-2	21,5
UT-10-32	86	195	9	100	32	25	37	PN-3	T20	VN-3	28
UT-10-32-L	126	235	9	100	32	25	37	PN-3	T20	VN-3	28
UT-12-32	104	213	9	100	32	30	37	PN-3	T20	VN-3	32
UT-12-32-L	161	270	9	100	32	30	37	PN-3	T20	VN-3	32
UT-14/16-32	126	235	9	100	32	35	37	PN-4	T20	VN-3	37
UT-14/16-32-L	180	289	9	100	32	35	37	PN-4	T20	VN-3	37
UT-18/25-32	140	249	9	100	32	40	45	PN-5	BR5	VN-4	45
UT-18/25-32-L	200	309	9	100	32	40	45	PN-5	BR5	VN-4	45



2 - 10 mm

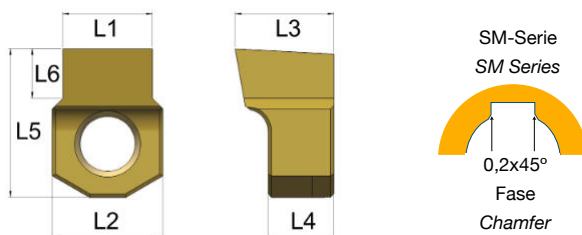

Längsnut
Keyway

Platte Insert	L1 mm	L2 mm	L3 mm	L4 mm	L5 mm	L6 mm	UT	RF
IN-02-P6/P9	1,994	5	6,5	5	6,5	1,3	UT-02	RF-1
IN-02-P6/P9-SM	1,994	5	6,5	5	6,5	1,09	UT-02	RF-1
IN-02-H7/JS9	2,010	5	6,5	5	6,5	1,3	UT-02	RF-1
IN-02-H7/JS9-SM	2,010	5	6,5	5	6,5	1,09	UT-02	RF-1
IN-02-D10	2,060	5	6,5	5	6,5	1,3	UT-02	RF-1
IN-02-C11	2,120	5	6,5	5	6,5	1,3	UT-02	RF-1
IN-03-P6/P9	2,994	6,08	6,5	5	7,5	2	UT-03	RF-1
IN-03-P6/P9-SM	2,994	6,08	6,5	5	7,5	1,42	UT-03	RF-1
IN-03-H7/JS9	3,010	6,08	6,5	5	7,5	2	UT-03	RF-1
IN-03-H7/JS9-SM	3,010	6,08	6,5	5	7,5	1,42	UT-03	RF-1
IN-03-D10	3,060	6,08	6,5	5	7,5	2	UT-03	RF-1
IN-03-C11	3,120	6,08	6,5	5	7,5	2	UT-03	RF-1
IN-04-P6/P9	3,988	6,08	7	5	8	2,6	UT-04	RF-1
IN-04-P6/P9-SM	3,988	6,08	7	5	8	2,07	UT-04	RF-1
IN-04-H7/JS9	4,012	6,08	7	5	8	2,6	UT-04	RF-1
IN-04-H7/JS9-SM	4,012	6,08	7	5	8	2,07	UT-04	RF-1
IN-04-D10	4,078	6,08	7	5	8	2,6	UT-04	RF-1
IN-04-C11	4,145	6,08	7	5	8	2,6	UT-04	RF-1
IN-05-P6/P9	4,988	6,08	7	5	8	3	UT-05	RF-1
IN-05-P6/P9-SM	4,988	6,08	7	5	8	2,74	UT-05	RF-1
IN-05-H7/JS9	5,012	6,08	7	5	8	3	UT-05	RF-1
IN-05-H7/JS9-SM	5,012	6,08	7	5	8	2,74	UT-05	RF-1
IN-05-D10	5,078	6,08	7	5	8	3	UT-05	RF-1
IN-05-C11	5,145	6,08	7	5	8	3	UT-05	RF-1
IN-06-P6/P9	5,988	10,08	9	6	13,5	4	UT-06	RF-2
IN-06-P6/P9-SM	5,988	10,08	9	6	13,5	3	UT-06	RF-2
IN-06-H7/JS9	6,012	10,08	9	6	13,5	4	UT-06	RF-2
IN-06-H7/JS9-SM	6,012	10,08	9	6	13,5	3	UT-06	RF-2
IN-06-D10	6,078	10,08	9	6	13,5	4	UT-06	RF-2
IN-06-C11	6,145	10,08	9	6	13,5	4	UT-06	RF-2
IN-08-P6/P9	7,985	10,08	9	6	13,5	4,5	UT-08	RF-2
IN-08-P6/P9-SM	7,985	10,08	9	6	13,5	3,78	UT-08	RF-2
IN-08-H7/JS9	8,015	10,08	9	6	13,5	4,5	UT-08	RF-2
IN-08-H7/JS9-SM	8,015	10,08	9	6	13,5	3,78	UT-08	RF-2
IN-08-D10	8,098	10,08	9	6	13,5	4,5	UT-08	RF-2
IN-08-C11	8,170	10,08	9	6	13,5	4,5	UT-08	RF-2
IN-10-P6/P9	9,985	13,1	14	10	18,5	6	UT-10	RF-3
IN-10-P6/P9-SM	9,985	13,1	14	10	18,5	3,88	UT-10	RF-3
IN-10-H7/JS9	10,015	13,1	14	10	18,5	6	UT-10	RF-3
IN-10-H7/JS9-SM	10,015	13,1	14	10	18,5	3,88	UT-10	RF-3
IN-10-D10	10,098	13,1	14	10	18,5	6	UT-10	RF-3
IN-10-C11	10,170	13,1	14	10	18,5	6	UT-10	RF-3

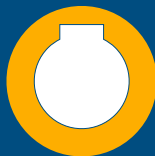

12 - 25 mm

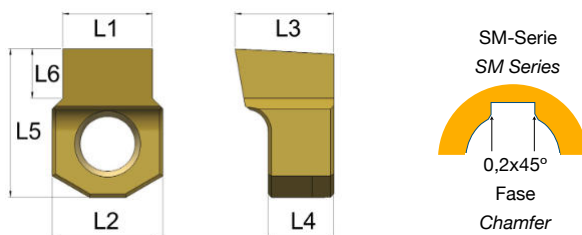

Längsnut
Keyway

Platte Insert	L1 mm	L2 mm	L3 mm	L4 mm	L5 mm	L6 mm	UT	RF
IN-12-P6/P9	11,982	13,1	14	10	18,5	6,5	UT-12	RF-3
IN-12-P6/P9-SM	11,982	13,1	14	10	18,5	3,89	UT-12	RF-3
IN-12-H7/JS9	12,018	13,1	14	10	18,5	6,5	UT-12	RF-3
IN-12-H7/JS9-SM	12,018	13,1	14	10	18,5	3,89	UT-12	RF-3
IN-12-D10	12,120	13,1	14	10	18,5	6,5	UT-12	RF-3
IN-12-C11	12,205	13,1	14	10	18,5	6,5	UT-12	RF-3
IN-14-P6/P9	13,982	18	14	10	22	7	UT-14/16	RF-4
IN-14-P6/P9-SM	13,982	18	14	10	22	4,71	UT-14/16	RF-4
IN-14-H7/JS9	14,018	18	14	10	22	7	UT-14/16	RF-4
IN-14-H7/JS9-SM	14,018	18	14	10	22	4,71	UT-14/16	RF-4
IN-14-D10	14,120	18	14	10	22	7	UT-14/16	RF-4
IN-14-C11	14,205	18	14	10	22	7	UT-14/16	RF-4
IN-16-P6/P9	15,982	18	14	10	22	8	UT-14/16	RF-4
IN-16-P6/P9-SM	15,982	18	14	10	22	5,53	UT-14/16	RF-4
IN-16-H7/JS9	16,018	18	14	10	22	8	UT-14/16	RF-4
IN-16-H7/JS9-SM	16,018	18	14	10	22	5,53	UT-14/16	RF-4
IN-16-D10	16,120	18	14	10	22	8	UT-14/16	RF-4
IN-16-C11	16,205	18	14	10	22	8	UT-14/16	RF-4
IN-18-P6/P9	17,982	26	18	10	30	11	UT-18/25	RF-5
IN-18-P6/P9-SM	17,982	26	18	10	30	5,67	UT-18/25	RF-5
IN-18-H7/JS9	18,018	26	18	10	30	11	UT-18/25	RF-5
IN-18-H7/JS9-SM	18,018	26	18	10	30	5,67	UT-18/25	RF-5
IN-18-D10	18,120	26	18	10	30	11	UT-18/25	RF-5
IN-18-C11	18,205	26	18	10	30	11	UT-18/25	RF-5
IN-20-P6/P9	19,978	26	18	10	30	10	UT-18/25	RF-5
IN-20-P6/P9-SM	19,978	26	18	10	30	6,29	UT-18/25	RF-5
IN-20-H7/JS9	20,021	26	18	10	30	10	UT-18/25	RF-5
IN-20-H7/JS9-SM	20,021	26	18	10	30	6,29	UT-18/25	RF-5
IN-20-D10	20,149	26	18	10	30	10	UT-18/25	RF-5
IN-20-C11	20,240	26	18	10	30	10	UT-18/25	RF-5
IN-22-P6/P9	21,978	26	18	10	30	11	UT-18/25	RF-5
IN-22-P6/P9-SM	21,978	26	18	10	30	6,79	UT-18/25	RF-5
IN-22-H7/JS9	22,021	26	18	10	30	11	UT-18/25	RF-5
IN-22-H7/JS9-SM	22,021	26	18	10	30	6,79	UT-18/25	RF-5
IN-22-D10	22,149	26	18	10	30	11	UT-18/25	RF-5
IN-22-C11	22,240	26	18	10	30	11	UT-18/25	RF-5
IN-25-P6/P9	24,978	26	18	10	30	12	UT-18/25	RF-5
IN-25-P6/P9-SM	24,978	26	18	10	30	7,02	UT-18/25	RF-5
IN-25-H7/JS9	25,021	26	18	10	30	12	UT-18/25	RF-5
IN-25-H7/JS9-SM	25,021	26	18	10	30	7,02	UT-18/25	RF-5
IN-25-D10	25,149	26	18	10	30	12	UT-18/25	RF-5
IN-25-C11	25,240	26	18	10	30	12	UT-18/25	RF-5



3/32" - 5/16"

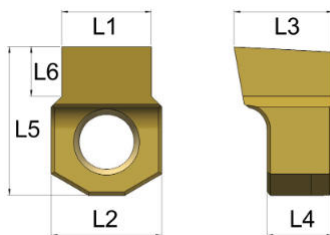

Längsnut
Keyway

Platte Insert	L1 mm	L1 inch	L2 inch	L3 inch	L4 inch	L5 inch	L6 inch	UT	RF
IN-3/32"-P6/P9	2.368	0.0932	0.1968	0.2362	0.1968	0.2559	0.0551	UT-02	RF-1
IN-3/32"-H7	2.391	0.0941	0.1968	0.2362	0.1968	0.2559	0.0551	UT-02	RF-1
IN-3/32"-D10	2.441	0.0961	0.1968	0.2362	0.1968	0.2559	0.0551	UT-02	RF-1
IN-3/32"-C11	2.500	0.0984	0.1968	0.2362	0.1968	0.2559	0.0551	UT-02	RF-1
IN-1/8"-P6/P9	3.158	0.1243	0.2393	0.2559	0.1968	0.2952	0.0905	UT-03	RF-1
IN-1/8"-H7	3.186	0.1254	0.2393	0.2559	0.1968	0.2952	0.0905	UT-03	RF-1
IN-1/8"-D10	3.252	0.1280	0.2393	0.2559	0.1968	0.2952	0.0905	UT-03	RF-1
IN-1/8"-C11	3.320	0.1307	0.2393	0.2559	0.1968	0.2952	0.0905	UT-03	RF-1
IN-5/32"-P6/P9	3.950	0.1555	0.2393	0.2755	0.1968	0.3149	0.1141	UT-04	RF-1
IN-5/32"-H7	3.981	0.1567	0.2393	0.2755	0.1968	0.3149	0.1141	UT-04	RF-1
IN-5/32"-D10	4.047	0.1593	0.2393	0.2755	0.1968	0.3149	0.1141	UT-04	RF-1
IN-5/32"-C11	4.113	0.1619	0.2393	0.2755	0.1968	0.3149	0.1141	UT-04	RF-1
IN-3/16"-P6/P9	4.745	0.1868	0.2393	0.2755	0.1968	0.3149	0.1299	UT-05	RF-1
IN-3/16"-H7	4.773	0.1879	0.2393	0.2755	0.1968	0.3149	0.1299	UT-05	RF-1
IN-3/16"-D10	4.839	0.1905	0.2393	0.2755	0.1968	0.3149	0.1299	UT-05	RF-1
IN-3/16"-C11	4.908	0.1932	0.2393	0.2755	0.1968	0.3149	0.1299	UT-05	RF-1
IN-1/4"-P6/P9	6.328	0.2491	0.3968	0.3543	0.2362	0.5314	0.1587	UT-06	RF-2
IN-1/4"-H7	6.363	0.2505	0.3968	0.3543	0.2362	0.5314	0.1587	UT-06	RF-2
IN-1/4"-D10	6.447	0.2538	0.3968	0.3543	0.2362	0.5314	0.1587	UT-06	RF-2
IN-1/4"-C11	6.518	0.2566	0.3968	0.3543	0.2362	0.5314	0.1587	UT-06	RF-2
IN-9/32"-P6/P9	7.123	0.2804	0.3968	0.3543	0.2362	0.5314	0.1692	UT-08	RF-2
IN-9/32"-H7	7.158	0.2818	0.3968	0.3543	0.2362	0.5314	0.1692	UT-08	RF-2
IN-9/32"-D10	7.242	0.2851	0.3968	0.3543	0.2362	0.5314	0.1692	UT-08	RF-2
IN-9/32"-C11	7.313	0.2879	0.3968	0.3543	0.2362	0.5314	0.1692	UT-08	RF-2
IN-5/16"-P6/P9	7.915	0.3116	0.3968	0.3543	0.2362	0.5314	0.1875	UT-08	RF-2
IN-5/16"-H7	7.951	0.3130	0.3968	0.3543	0.2362	0.5314	0.1875	UT-08	RF-2
IN-5/16"-D10	8.035	0.3163	0.3968	0.3543	0.2362	0.5314	0.1875	UT-08	RF-2
IN-5/16"-C11	8.106	0.3191	0.3968	0.3543	0.2362	0.5314	0.1875	UT-08	RF-2



3/8" - 3/4"

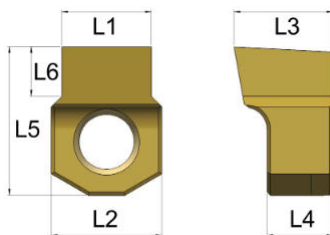

Längsnut
Keyway

Platte Insert	L1 mm	L1 inch	L2 inch	L3 inch	L4 inch	L5 inch	L6 inch	UT	RF
IN-3/8"-P6/P9	9.503	0.3741	0.5157	0.5511	0.3937	0.7283	0.2500	UT-10	RF-3
IN-3/8"-H7	9.538	0.3755	0.5157	0.5511	0.3937	0.7283	0.2500	UT-10	RF-3
IN-3/8"-D10	9.622	0.3788	0.5157	0.5511	0.3937	0.7283	0.2500	UT-10	RF-3
IN-3/8"-C11	9.693	0.3816	0.5157	0.5511	0.3937	0.7283	0.2500	UT-10	RF-3
IN-7/16"-P6/P9	11.085	0.4364	0.5157	0.5511	0.3937	0.7283	0.2500	UT-12	RF-3
IN-7/16"-H7	11.131	0.4382	0.5157	0.5511	0.3937	0.7283	0.2500	UT-12	RF-3
IN-7/16"-D10	11.232	0.4422	0.5157	0.5511	0.3937	0.7283	0.2500	UT-12	RF-3
IN-7/16"-C11	11.316	0.4455	0.5157	0.5511	0.3937	0.7283	0.2500	UT-12	RF-3
IN-1/2"-P6/P9	12.673	0.4989	0.5157	0.5511	0.3937	0.7283	0.3000	UT-12	RF-3
IN-1/2"-H7	12.718	0.5007	0.5157	0.5511	0.3937	0.7283	0.3000	UT-12	RF-3
IN-1/2"-D10	12.820	0.5047	0.5157	0.5511	0.3937	0.7283	0.3000	UT-12	RF-3
IN-1/2"-C11	12.904	0.5080	0.5157	0.5511	0.3937	0.7283	0.3000	UT-12	RF-3
IN-9/16"-P6/P9	14.260	0.5614	0.7086	0.5511	0.3937	0.8661	0.2750	UT-14/16	RF-4
IN-9/16"-H7	14.306	0.5632	0.7086	0.5511	0.3937	0.8661	0.2750	UT-14/16	RF-4
IN-9/16"-D10	14.407	0.5672	0.7086	0.5511	0.3937	0.8661	0.2750	UT-14/16	RF-4
IN-9/16"-C11	14.491	0.5705	0.7086	0.5511	0.3937	0.8661	0.2750	UT-14/16	RF-4
IN-5/8"-P6/P9	15.848	0.6239	0.7086	0.5511	0.3937	0.8661	0.3120	UT-14/16	RF-4
IN-5/8"-H7	15.893	0.6257	0.7086	0.5511	0.3937	0.8661	0.3120	UT-14/16	RF-4
IN-5/8"-D10	15.995	0.6297	0.7086	0.5511	0.3937	0.8661	0.3120	UT-14/16	RF-4
IN-5/8"-C11	16.079	0.6330	0.7086	0.5511	0.3937	0.8661	0.3120	UT-14/16	RF-4
IN-3/4"-P6/P9	19.017	0.7487	1.0240	0.7086	0.3937	1.1810	0.3930	UT-18/25	RF-4
IN-3/4"-H7	19.071	0.7508	1.0240	0.7086	0.3937	1.1810	0.3930	UT-18/25	RF-4
IN-3/4"-D10	19.198	0.7558	1.0240	0.7086	0.3937	1.1810	0.3930	UT-18/25	RF-4
IN-3/4"-C11	19.289	0.7594	1.0240	0.7086	0.3937	1.1810	0.3930	UT-18/25	RF-4



2 - 10 mm

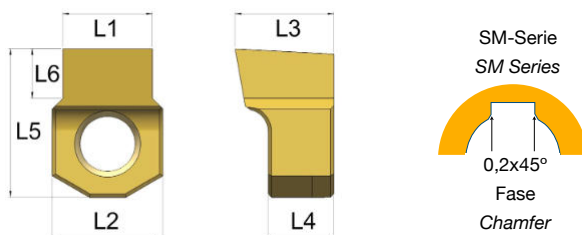

Längsnut
Keyway

Platte Insert	L1 mm	L2 mm	L3 mm	L4 mm	L5 mm	L6 mm	UT	RF
INR-02-P6/P9 HM	1,994	5	6,5	5	6,5	1,3	UT-02	RF-1
INR-02-P6/P9-SM HM	1,994	5	6,5	5	6,5	1,09	UT-02	RF-1
INR-02-H7/JS9 HM	2,010	5	6,5	5	6,5	1,3	UT-02	RF-1
INR-02-H7/JS9-SM HM	2,010	5	6,5	5	6,5	1,09	UT-02	RF-1
INR-02-D10 HM	2,060	5	6,5	5	6,5	1,3	UT-02	RF-1
INR-02-C11 HM	2,120	5	6,5	5	6,5	1,3	UT-02	RF-1
INR-03-P6/P9 HM	2,994	6,08	6,5	5	7,5	2	UT-03	RF-1
INR-03-P6/P9-SM HM	2,994	6,08	6,5	5	7,5	1,42	UT-03	RF-1
INR-03-H7/JS9 HM	3,010	6,08	6,5	5	7,5	2	UT-03	RF-1
INR-03-H7/JS9-SM HM	3,010	6,08	6,5	5	7,5	1,42	UT-03	RF-1
INR-03-D10 HM	3,060	6,08	6,5	5	7,5	2	UT-03	RF-1
INR-03-C11 HM	3,120	6,08	6,5	5	7,5	2	UT-03	RF-1
INR-04-P6/P9 HM	3,988	6,08	7	5	8	2,6	UT-04	RF-1
INR-04-P6/P9-SM HM	3,988	6,08	7	5	8	2,07	UT-04	RF-1
INR-04-H7/JS9 HM	4,012	6,08	7	5	8	2,6	UT-04	RF-1
INR-04-H7/JS9-SM HM	4,012	6,08	7	5	8	2,07	UT-04	RF-1
INR-04-D10 HM	4,078	6,08	7	5	8	2,6	UT-04	RF-1
INR-04-C11 HM	4,145	6,08	7	5	8	2,6	UT-04	RF-1
INR-05-P6/P9 HM	4,988	6,08	7	5	8	3	UT-05	RF-1
INR-05-P6/P9-SM HM	4,988	6,08	7	5	8	2,74	UT-05	RF-1
INR-05-H7/JS9 HM	5,012	6,08	7	5	8	3	UT-05	RF-1
INR-05-H7/JS9-SM HM	5,012	6,08	7	5	8	2,74	UT-05	RF-1
INR-05-D10 HM	5,078	6,08	7	5	8	3	UT-05	RF-1
INR-05-C11 HM	5,145	6,08	7	5	8	3	UT-05	RF-1
INR-06-P6/P9 HM	5,988	10,08	9	6	13,5	4	UT-06	RF-2
INR-06-P6/P9-SM HM	5,988	10,08	9	6	13,5	3	UT-06	RF-2
INR-06-H7/JS9 HM	6,012	10,08	9	6	13,5	4	UT-06	RF-2
INR-06-H7/JS9-SM HM	6,012	10,08	9	6	13,5	3	UT-06	RF-2
INR-06-D10 HM	6,078	10,08	9	6	13,5	4	UT-06	RF-2
INR-06-C11 HM	6,145	10,08	9	6	13,5	4	UT-06	RF-2
INR-08-P6/P9 HM	7,985	10,08	9	6	13,5	4,5	UT-08	RF-2
INR-08-P6/P9-SM HM	7,985	10,08	9	6	13,5	3,78	UT-08	RF-2
INR-08-H7/JS9 HM	8,015	10,08	9	6	13,5	4,5	UT-08	RF-2
INR-08-H7/JS9-SM HM	8,015	10,08	9	6	13,5	3,78	UT-08	RF-2
INR-08-D10 HM	8,098	10,08	9	6	13,5	4,5	UT-08	RF-2
INR-08-C11 HM	8,170	10,08	9	6	13,5	4,5	UT-08	RF-2
INR-10-P6/P9 HM	9,985	13,1	14	10	18,5	6	UT-10	RF-3
INR-10-P6/P9-SM HM	9,985	13,1	14	10	18,5	3,88	UT-10	RF-3
INR-10-H7/JS9 HM	10,015	13,1	14	10	18,5	6	UT-10	RF-3
INR-10-H7/JS9-SM HM	10,015	13,1	14	10	18,5	3,88	UT-10	RF-3
INR-10-D10 HM	10,098	13,1	14	10	18,5	6	UT-10	RF-3
INR-10-C11 HM	10,170	13,1	14	10	18,5	6	UT-10	RF-3



12 - 25 mm

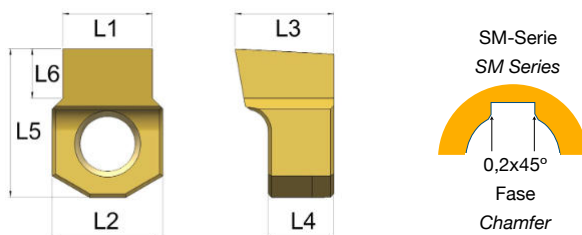

Längsnut
Keyway

Platte Insert	L1 mm	L2 mm	L3 mm	L4 mm	L5 mm	L6 mm	UT	RF
INR-12-P6/P9 HM	11,982	13,1	14	10	18,5	6,5	UT-12	RF-3
INR-12-P6/P9-SM HM	11,982	13,1	14	10	18,5	3,89	UT-12	RF-3
INR-12-H7/JS9 HM	12,018	13,1	14	10	18,5	6,5	UT-12	RF-3
INR-12-H7/JS9-SM HM	12,018	13,1	14	10	18,5	3,89	UT-12	RF-3
INR-12-D10 HM	12,120	13,1	14	10	18,5	6,5	UT-12	RF-3
INR-12-C11 HM	12,205	13,1	14	10	18,5	6,5	UT-12	RF-3
INR-14-P6/P9 HM	13,982	18	14	10	22	7	UT-14/16	RF-4
INR-14-P6/P9-SM HM	13,982	18	14	10	22	4,71	UT-14/16	RF-4
INR-14-H7/JS9 HM	14,018	18	14	10	22	7	UT-14/16	RF-4
INR-14-H7/JS9-SM HM	14,018	18	14	10	22	4,71	UT-14/16	RF-4
INR-14-D10 HM	14,120	18	14	10	22	7	UT-14/16	RF-4
INR-14-C11 HM	14,205	18	14	10	22	7	UT-14/16	RF-4
INR-16-P6/P9 HM	15,982	18	14	10	22	8	UT-14/16	RF-4
INR-16-P6/P9-SM HM	15,982	18	14	10	22	5,53	UT-14/16	RF-4
INR-16-H7/JS9 HM	16,018	18	14	10	22	8	UT-14/16	RF-4
INR-16-H7/JS9-SM HM	16,018	18	14	10	22	5,53	UT-14/16	RF-4
INR-16-D10 HM	16,120	18	14	10	22	8	UT-14/16	RF-4
INR-16-C11 HM	16,205	18	14	10	22	8	UT-14/16	RF-4
INR-18-P6/P9 HM	17,982	26	18	10	30	11	UT-18/25	RF-5
INR-18-P6/P9-SM HM	17,982	26	18	10	30	5,67	UT-18/25	RF-5
INR-18-H7/JS9 HM	18,018	26	18	10	30	11	UT-18/25	RF-5
INR-18-H7/JS9-SM HM	18,018	26	18	10	30	5,67	UT-18/25	RF-5
INR-18-D10 HM	18,120	26	18	10	30	11	UT-18/25	RF-5
INR-18-C11 HM	18,205	26	18	10	30	11	UT-18/25	RF-5
INR-20-P6/P9 HM	19,978	26	18	10	30	10	UT-18/25	RF-5
INR-20-P6/P9-SM HM	19,978	26	18	10	30	6,29	UT-18/25	RF-5
INR-20-H7/JS9 HM	20,021	26	18	10	30	10	UT-18/25	RF-5
INR-20-H7/JS9-SM HM	20,021	26	18	10	30	6,29	UT-18/25	RF-5
INR-20-D10 HM	20,149	26	18	10	30	10	UT-18/25	RF-5
INR-20-C11 HM	20,240	26	18	10	30	10	UT-18/25	RF-5
INR-22-P6/P9 HM	21,978	26	18	10	30	11	UT-18/25	RF-5
INR-22-P6/P9-SM HM	21,978	26	18	10	30	6,79	UT-18/25	RF-5
INR-22-H7/JS9 HM	22,021	26	18	10	30	11	UT-18/25	RF-5
INR-22-H7/JS9-SM HM	22,021	26	18	10	30	6,79	UT-18/25	RF-5
INR-22-D10 HM	22,149	26	18	10	30	11	UT-18/25	RF-5
INR-22-C11 HM	22,240	26	18	10	30	11	UT-18/25	RF-5
INR-25-P6/P9 HM	24,978	26	18	10	30	12	UT-18/25	RF-5
INR-25-P6/P9-SM HM	24,978	26	18	10	30	7,02	UT-18/25	RF-5
INR-25-H7/JS9 HM	25,021	26	18	10	30	12	UT-18/25	RF-5
INR-25-H7/JS9-SM HM	25,021	26	18	10	30	7,02	UT-18/25	RF-5
INR-25-D10 HM	25,149	26	18	10	30	12	UT-18/25	RF-5
INR-25-C11 HM	25,240	26	18	10	30	12	UT-18/25	RF-5



3/32" - 5/16"

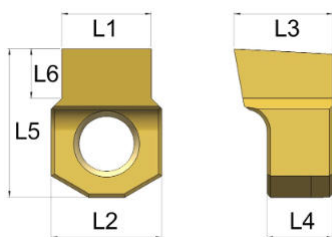

Längsnut
Keyway

Platte Insert	L1 mm	L1 inch	L2 inch	L3 inch	L4 inch	L5 inch	L6 inch	UT	RF
INR-3/32"-P6/P9 HM	2.368	0.0932	0.1968	0.2362	0.1968	0.2559	0.0551	UT-02	RF-1
INR-3/32"-H7 HM	2.391	0.0941	0.1968	0.2362	0.1968	0.2559	0.0551	UT-02	RF-1
INR-3/32"-D10 HM	2.441	0.0961	0.1968	0.2362	0.1968	0.2559	0.0551	UT-02	RF-1
INR-3/32"-C11 HM	2.500	0.0984	0.1968	0.2362	0.1968	0.2559	0.0551	UT-02	RF-1
INR-1/8"-P6/P9 HM	3.158	0.1243	0.2393	0.2559	0.1968	0.2952	0.0905	UT-03	RF-1
INR-1/8"-H7 HM	3.186	0.1254	0.2393	0.2559	0.1968	0.2952	0.0905	UT-03	RF-1
INR-1/8"-D10 HM	3.252	0.1280	0.2393	0.2559	0.1968	0.2952	0.0905	UT-03	RF-1
INR-1/8"-C11 HM	3.320	0.1307	0.2393	0.2559	0.1968	0.2952	0.0905	UT-03	RF-1
INR-5/32"-P6/P9 HM	3.950	0.1555	0.2393	0.2755	0.1968	0.3149	0.1141	UT-04	RF-1
INR-5/32"-H7 HM	3.981	0.1567	0.2393	0.2755	0.1968	0.3149	0.1141	UT-04	RF-1
INR-5/32"-D10 HM	4.047	0.1593	0.2393	0.2755	0.1968	0.3149	0.1141	UT-04	RF-1
INR-5/32"-C11 HM	4.113	0.1619	0.2393	0.2755	0.1968	0.3149	0.1141	UT-04	RF-1
INR-3/16"-P6/P9 HM	4.745	0.1868	0.2393	0.2755	0.1968	0.3149	0.1299	UT-05	RF-1
INR-3/16"-H7 HM	4.773	0.1879	0.2393	0.2755	0.1968	0.3149	0.1299	UT-05	RF-1
INR-3/16"-D10 HM	4.839	0.1905	0.2393	0.2755	0.1968	0.3149	0.1299	UT-05	RF-1
INR-3/16"-C11 HM	4.908	0.1932	0.2393	0.2755	0.1968	0.3149	0.1299	UT-05	RF-1
INR-1/4"-P6/P9 HM	6.328	0.2491	0.3968	0.3543	0.2362	0.5314	0.1587	UT-06	RF-2
INR-1/4"-H7 HM	6.363	0.2505	0.3968	0.3543	0.2362	0.5314	0.1587	UT-06	RF-2
INR-1/4"-D10 HM	6.447	0.2538	0.3968	0.3543	0.2362	0.5314	0.1587	UT-06	RF-2
INR-1/4"-C11 HM	6.518	0.2566	0.3968	0.3543	0.2362	0.5314	0.1587	UT-06	RF-2
INR-9/32"-P6/P9 HM	7.123	0.2804	0.3968	0.3543	0.2362	0.5314	0.1692	UT-08	RF-2
INR-9/32"-H7 HM	7.158	0.2818	0.3968	0.3543	0.2362	0.5314	0.1692	UT-08	RF-2
INR-9/32"-D10 HM	7.242	0.2851	0.3968	0.3543	0.2362	0.5314	0.1692	UT-08	RF-2
INR-9/32"-C11 HM	7.313	0.2879	0.3968	0.3543	0.2362	0.5314	0.1692	UT-08	RF-2
INR-5/16"-P6/P9 HM	7.915	0.3116	0.3968	0.3543	0.2362	0.5314	0.1875	UT-08	RF-2
INR-5/16"-H7 HM	7.951	0.3130	0.3968	0.3543	0.2362	0.5314	0.1875	UT-08	RF-2
INR-5/16"-D10 HM	8.035	0.3163	0.3968	0.3543	0.2362	0.5314	0.1875	UT-08	RF-2
INR-5/16"-C11 HM	8.106	0.3191	0.3968	0.3543	0.2362	0.5314	0.1875	UT-08	RF-2



3/8" - 3/4"

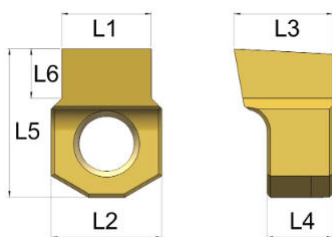

Längsnut
Keyway

Platte Insert	L1 mm	L1 inch	L2 inch	L3 inch	L4 inch	L5 inch	L6 inch	UT	RF
INR-3/8"-P6/P9 HM	9.503	0.3741	0.5157	0.5511	0.3937	0.7283	0.2500	UT-10	RF-3
INR-3/8"-H7 HM	9.538	0.3755	0.5157	0.5511	0.3937	0.7283	0.2500	UT-10	RF-3
INR-3/8"-D10 HM	9.622	0.3788	0.5157	0.5511	0.3937	0.7283	0.2500	UT-10	RF-3
INR-3/8"-C11 HM	9.693	0.3816	0.5157	0.5511	0.3937	0.7283	0.2500	UT-10	RF-3
INR-7/16"-P6/P9 HM	11.085	0.4364	0.5157	0.5511	0.3937	0.7283	0.2500	UT-12	RF-3
INR-7/16"-H7 HM	11.131	0.4382	0.5157	0.5511	0.3937	0.7283	0.2500	UT-12	RF-3
INR-7/16"-D10 HM	11.232	0.4422	0.5157	0.5511	0.3937	0.7283	0.2500	UT-12	RF-3
INR-7/16"-C11 HM	11.316	0.4455	0.5157	0.5511	0.3937	0.7283	0.2500	UT-12	RF-3
INR-1/2"-P6/P9 HM	12.673	0.4989	0.5157	0.5511	0.3937	0.7283	0.3000	UT-12	RF-3
INR-1/2"-H7 HM	12.718	0.5007	0.5157	0.5511	0.3937	0.7283	0.3000	UT-12	RF-3
INR-1/2"-D10 HM	12.820	0.5047	0.5157	0.5511	0.3937	0.7283	0.3000	UT-12	RF-3
INR-1/2"-C11 HM	12.904	0.5080	0.5157	0.5511	0.3937	0.7283	0.3000	UT-12	RF-3
INR-9/16"-P6/P9 HM	14.260	0.5614	0.7086	0.5511	0.3937	0.8661	0.2750	UT-14/16	RF-4
INR-9/16"-H7 HM	14.306	0.5632	0.7086	0.5511	0.3937	0.8661	0.2750	UT-14/16	RF-4
INR-9/16"-D10 HM	14.407	0.5672	0.7086	0.5511	0.3937	0.8661	0.2750	UT-14/16	RF-4
INR-9/16"-C11 HM	14.491	0.5705	0.7086	0.5511	0.3937	0.8661	0.2750	UT-14/16	RF-4
INR-5/8"-P6/P9 HM	15.848	0.6239	0.7086	0.5511	0.3937	0.8661	0.3120	UT-14/16	RF-4
INR-5/8"-H7 HM	15.893	0.6257	0.7086	0.5511	0.3937	0.8661	0.3120	UT-14/16	RF-4
INR-5/8"-D10 HM	15.995	0.6297	0.7086	0.5511	0.3937	0.8661	0.3120	UT-14/16	RF-4
INR-5/8"-C11 HM	16.079	0.6330	0.7086	0.5511	0.3937	0.8661	0.3120	UT-14/16	RF-4
INR-3/4"-P6/P9 HM	19.017	0.7487	1.0240	0.7086	0.3937	1.1810	0.3930	UT-18/25	RF-4
INR-3/4"-H7 HM	19.071	0.7508	1.0240	0.7086	0.3937	1.1810	0.3930	UT-18/25	RF-4
INR-3/4"-D10 HM	19.198	0.7558	1.0240	0.7086	0.3937	1.1810	0.3930	UT-18/25	RF-4
INR-3/4"-C11 HM	19.289	0.7594	1.0240	0.7086	0.3937	1.1810	0.3930	UT-18/25	RF-4



8 - 50 mm
0.32" - 1.96"

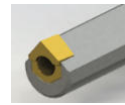
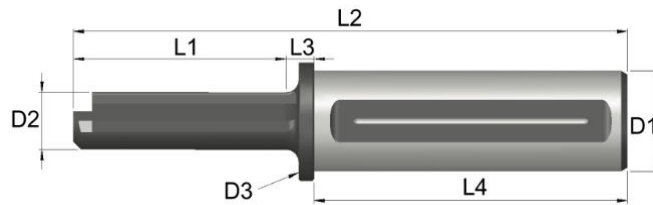

Halter Holder	L1 mm	L2 mm	L3 mm	L4 mm	D1 mm	D2 mm	D3 mm	PN	T	VN	Min Ø mm
UT-SQ-8/10-25	30	129	9	90	25	7,25	30	PN-1	T08	VN-1	8
UT-SQ-10/13-25	40	139	9	90	25	8,6	30	PN-1	T08	VN-1	10
UT-SQ-13/16-25	50	149	9	90	25	12	30	PN-2	T15	VN-2	13
UT-SQ-16/19-25	52	151	9	90	25	15	30	PN-3	T20	VN-3	16
UT-SQ-19/27-25	86	185	9	90	25	18,5	30	PN-3	T20	VN-3	19
UT-SQ-27/37-25	100	199	9	90	25	25	30	PN-4	T20	VN-3	27
UT-SQ-8/10-32	30	139	9	100	32	7,25	38	PN-1	T08	VN-1	8
UT-SQ-10/13-32	40	149	9	100	32	8,6	38	PN-1	T08	VN-1	10
UT-SQ-13/16-32	50	159	9	100	32	12	38	PN-2	T15	VN-2	13
UT-SQ-16/19-32	52	161	9	100	32	15	38	PN-3	T20	VN-3	16
UT-SQ-19/27-32	86	195	9	100	32	18,5	38	PN-3	T20	VN-3	19
UT-SQ-27/37-32	100	209	9	100	32	25	38	PN-4	T20	VN-3	27
UT-SQ-37/50-32	140	249	9	100	32	35	45	PN-5	BR5	VN-4	37

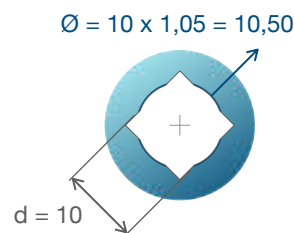
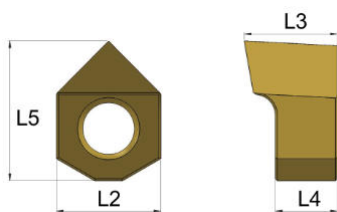

Vorbohrung / Pre-hole
Ø = d x 1,05

Platte Insert	Bereich (mm) Range (mm)	Bereich (Zoll) Range (inch)	L2 mm	L3 mm	L4 mm	L5 mm	UT	RF
IN-SQ-8/10	8-10	0.314-0.393	6	7	5	7	UT-SQ-8/10	RF-1
IN-SQ-10/13	10-13	0.393-0.511	6	7	5	7,5	UT-SQ-10/13	RF-1
IN-SQ-13/16	13-16	0.511-0.629	10	8	6	12	UT-SQ-13/16	RF-2
IN-SQ-16/19	16-19	0.629-0.748	10	8	6	12,5	UT-SQ-16/19	RF-2
IN-SQ-19/27	19-27	0.748-1.062	13	13	10	17	UT-SQ-19/27	RF-3
IN-SQ-27/37	27-37	1.062-1.456	18	14	10	22	UT-SQ-27/37	RF-4
IN-SQ-37/50	37-50	1.456-1.968	26	18	10	31	UT-SQ-37/50	RF-5

Klemhalter - Sechskant Hexagon Broaching Holders

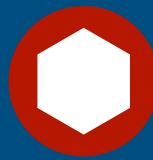

Gisstec®

9 - 70 mm
0.36" - 2.75"

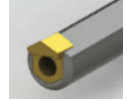
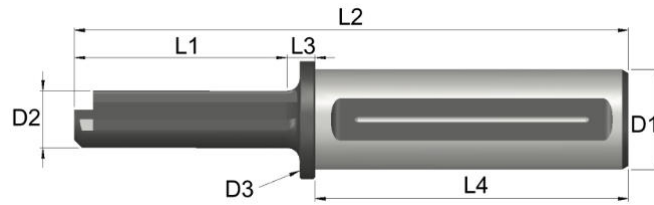

Halter Holder	L1 mm	L2 mm	L3 mm	L4 mm	D1 mm	D2 mm	D3 mm	PN	T	VN	Min Ø mm
UT-HEX-9/11-25	30	129	9	90	25	8	30	PN-1	T08	VN-1	9
UT-HEX-11/17-25	40	139	9	90	25	10	30	PN-1	T08	VN-1	11
UT-HEX-17/28-25	56	155	9	90	25	15	30	PN-2	T15	VN-2	17
UT-HEX-28/37-25	86	185	9	90	25	25	30	PN-3	T20	VN-3	28
UT-HEX-37/45-25	126	225	9	90	25	35	45	PN-4	T20	VN-3	37
UT-HEX-9/11-32	30	139	9	100	32	8	38	PN-1	T08	VN-1	9
UT-HEX-11/17-32	40	149	9	100	32	10	38	PN-1	T08	VN-1	11
UT-HEX-17/28-32	56	165	9	100	32	15	38	PN-2	T15	VN-2	17
UT-HEX-28/37-32	86	195	9	100	32	25	38	PN-3	T20	VN-3	28
UT-HEX-37/45-32	126	235	9	100	32	35	45	PN-4	T20	VN-3	37
UT-HEX-45/70-32	140	249	9	100	32	40	45	PN-5	BR5	VN-4	45

Stoßplatten - Sechskant Hexagon Broaching Inserts



Gisstec®

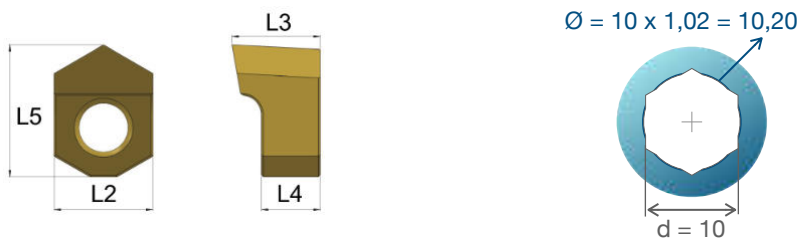

Vorbohrung / Pre-hole

$\varnothing = d \times 1,02$

Platte Insert	Bereich (mm) Range (mm)	Bereich (Zoll) Range (inch)	L2 mm	L3 mm	L4 mm	L5 mm	UT	RF
IN-HEX-9/11	9-11	0.354-0.433	6	7	5	7,5	UT-HEX-9/11	RF-1
IN-HEX-11/17	11-17	0.433-0.669	6	7	5	8	UT-HEX-11/17	RF-1
IN-HEX-17/28	17-28	0.669/1.102	10	9	6	13,5	UT-HEX-17/28	RF-2
IN-HEX-28/37	28-37	1.102/1.456	13	14	10	18,5	UT-HEX-28/37	RF-3
IN-HEX-37/45	37-45	1.456/1.771	18	14	10	22	UT-HEX-37/45	RF-4
IN-HEX-45/70	45-70	1.771/2.755	26	16	10	30	UT-HEX-45/70	RF-5

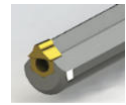
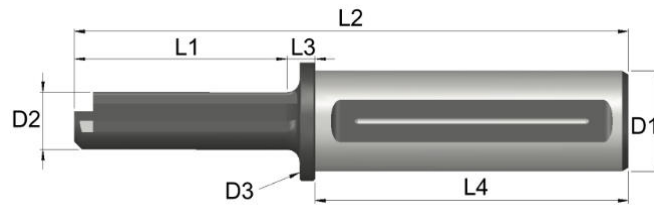
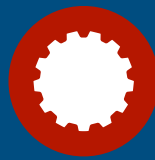

Halter Holder	L1 mm	L2 mm	L3 mm	L4 mm	D1 mm	D2 mm	D3 mm	PN	T	VN	Min Ø mm
UTS-02-25	25	124	9	90	25	6,5	30	PN-1	T08	VN-1	7
UTS-03-25	30	129	9	90	25	8	30	PN-1	T08	VN-1	8,5
UTS-04-25	40	139	9	90	25	10	30	PN-1	T08	VN-1	10,5
UTS-05-25	46	145	9	90	25	12	30	PN-1	T08	VN-1	12,5
UTS-06-25	56	155	9	90	25	16	30	PN-2	T15	VN-2	16,5
UTS-08-25	68	162	9	90	25	20	30	PN-2	T15	VN-2	21
UTS-10-25	86	185	9	90	25	25	30	PN-3	T20	VN-3	28
UTS-12-25	102	203	9	90	25	30	30	PN-3	T20	VN-3	33
UTS-14/16-25	126	221	5	90	25	35	37	PN-4	T20	VN-3	38
UTS-02-32	25	134	9	100	32	6,5	37	PN-1	T08	VN-1	7
UTS-03-32	30	139	9	100	32	8	37	PN-1	T08	VN-1	8,5
UTS-04-32	40	149	9	100	32	10	37	PN-1	T08	VN-1	10,5
UTS-05-32	46	155	9	100	32	12	37	PN-1	T08	VN-1	12,5
UTS-06-32	56	165	9	100	32	16	37	PN-2	T15	VN-2	16,5
UTS-08-32	68	172	9	100	32	20	37	PN-2	T15	VN-2	21
UTS-10-32	86	195	9	100	32	25	37	PN-3	T20	VN-3	28
UTS-12-32	102	213	9	100	32	30	37	PN-3	T20	VN-3	33
UTS-14/16-32	126	231	9	100	32	35	37	PN-4	T20	VN-3	38
UTS-18/25-32	140	249	9	100	32	40	45	PN-5	BR.5	VN-4	42



- ✓ Platten für Verzahnungsprofile werden nach Kundenzeichnung gefertigt.
- ✓ Mindestbestellmenge: Zwei Stück
- ✓ Sonderpreis ab 10 Stück



- ✓ Inserts for spline profiles are manufactured according to customer's technical drawings
- ✓ Minimum Order Quantity: Two pieces
- ✓ Special price for orders of 10+ pieces

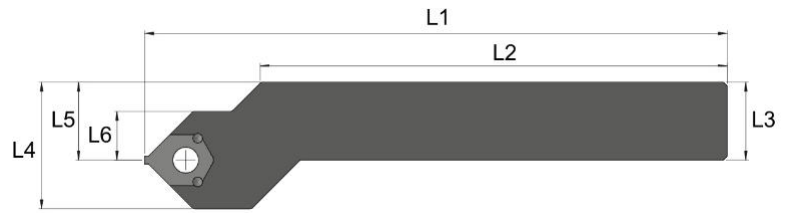

Halter Holder	L1 mm	L2 mm	L3 mm	L4 mm	L5 mm	L6 mm
UTE-20-DX	150	110	20x20	32,5	20	12,5
UTE-20-SX	150	110	20x20	32,5	20	12,5
UTE-25-DX	150	110	25x25	37,5	25	12,5
UTE-25-SX	150	110	25x25	37,5	25	12,5

Mini-Nutstoßwerkzeuge
Mini Broaching Tools

Halter
Holder

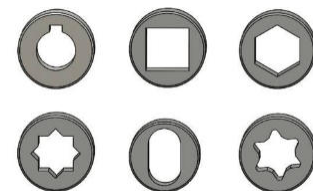
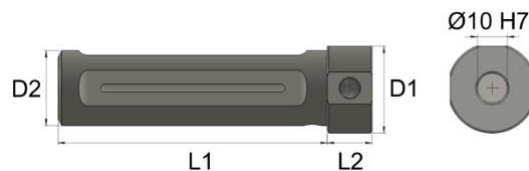

Halter Holder	L1 mm	L2 mm	D1 mm	D2 mm
UT-1/8-19.05	90	15	30	19,05
UT-1/8-20	90	15	30	20
UT-1/8-25	90	15	30	25
UT-1/8-32	100	15	38	32

Platte
Insert

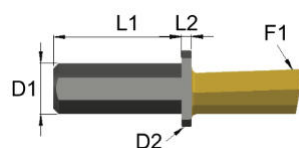

Platte Insert	L1 mm	L2 mm	F1 mm	D1 mm	D2 mm
IN-1/8	18	2	Auf Anfrage On request	10 H7	15



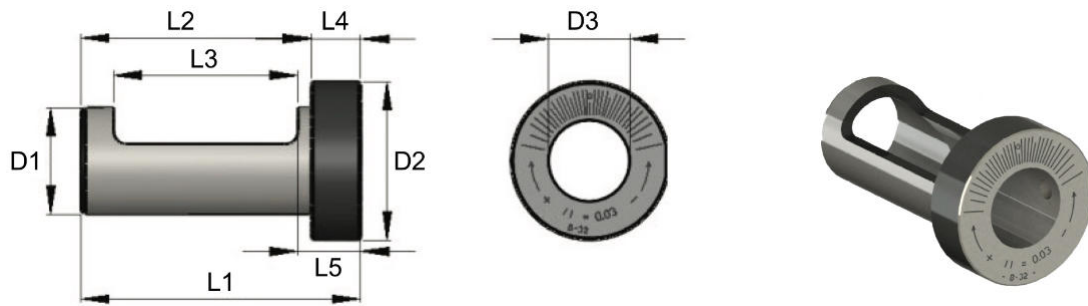

Buchse Bushing	L1 mm	L2 mm	L3 mm	L4 mm	L5 mm	D1 mm	D2 mm	D3 mm
B-32	85	70	58	15	20	32 H7	48	25
B-40	95	80	66	15	20	40 H7	55	32
B-50	115	100	75	15	20	50 H7	65	32
B-60	115	100	75	15	20	60 H7	80	32
B-32-VDI	65	50	38	15	20	32 H7	48	25
B-40-VDI	80	65	51	15	20	40 H7	55	32
B-50-VDI	95	80	55	15	20	50 H7	65	32
B-60-VDI	105	80	65	15	20	60 H7	80	32

Buchse Bushing	L1 inch	L2 inch	L3 inch	L4 inch	L5 inch	D1 inch	D2 inch	D3 inch
B-1-1/4in	3.346	2.756	2.283	0.591	0.787	1.25	2.165	0.984
B-1-1/2in	3.740	3.150	2.598	0.591	0.787	1.50	2.165	1.260
B-2in	4.528	3.937	2.953	0.591	0.787	2.00	2.559	1.260
B-1-1/4in-VDI	2.559	1.969	1.496	0.591	0.787	1.25	2.165	0.984
B-1-1/2in-VDI	3.150	2.559	2.008	0.591	0.787	1.50	2.165	1.260
B-2in-VDI	3.740	3.150	2.165	0.591	0.787	2.00	2.559	1.260

- ☑ Exzentrische Buchse für Drehmaschinen ohne Y-Achse, zur Achsen-Korrektur
- ☑ Gefertigt aus gehärtetem Werkzeugstahl
- ☑ Verstellung auf Y-Achse:
0,5 mm Y+
0,5 mm Y-

- ☑ The eccentric bushing is necessary for lathes without Y axis for axis correction
- ☑ Manufactured with tempered tool steel
- ☑ Correction on Y axis:
0.5 mm Y+
0.5 mm Y-

AD

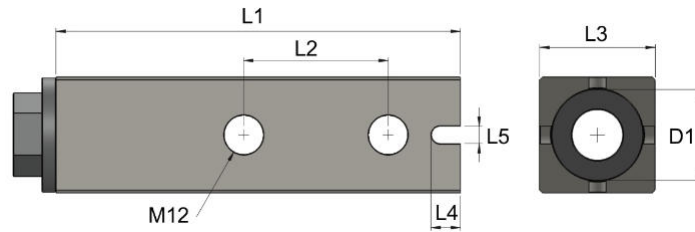

Adapter	L1 mm	L2 mm	L3 mm	L4 mm	L5 mm	D1 mm
AD-35	140	40	35	10	6	25
AD-40	140	50	40	10	6	32
AD-50	170	50	50	10	6	32

ADP Prisma

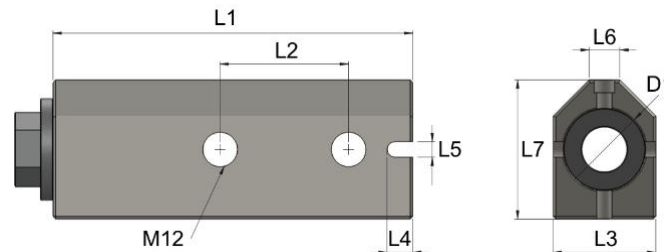

Adapter	L1 mm	L2 mm	L3 mm	L4 mm	L5 mm	L6 mm	L7 mm	D1 mm
ADP-35	140	40	35	10	6	10	41,5	25
ADP-40	140	50	40	10	6	10	50	32
ADP-50	140	50	50	10	6	10		32

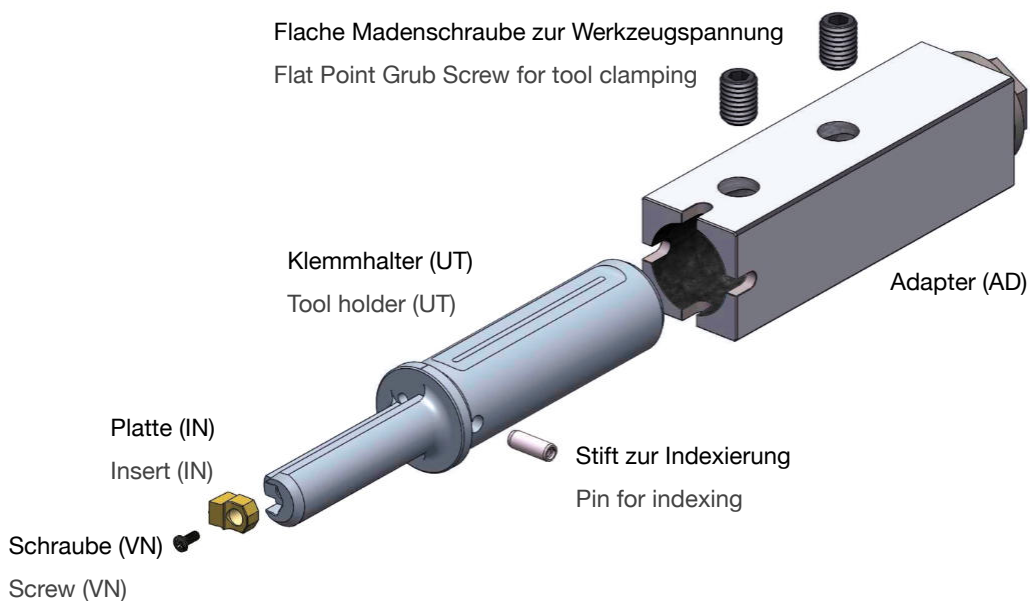

Ausrichthilfe für Bearbeitungszentren (PN)
Centring Plate for CNC Milling (PN)

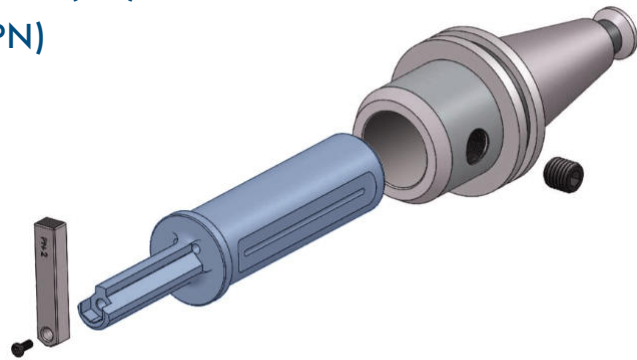
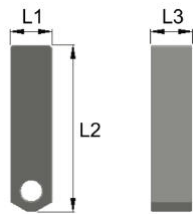

Artikelnr. Code	L1 mm	L2 mm	L3 mm	Werkzeuge Tools
PN-0	5	50	6	UT-02
PN-1	6,08	50	8	UT-03, UT-04, UT-05
PN-2	10,08	50	8	UT-06, UT-08
PN-3	13,1	60	10	UT-10, UT-12
PN-4	18	70	10	UT-14/16
PN-5	26	70	10	UT-18/25

Nachschleifhalter (RF)
Sharpening Stems (RF)

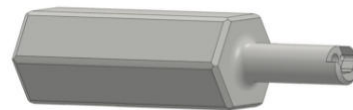
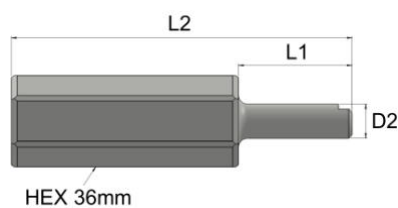

Artikelnr. Code	L1 mm	L2 mm	D2 mm	Platten Inserts
RF-0	50	150	10	2 mm
RF-1	50	150	12	3-4-5 mm
RF-2	50	150	15	6-8 mm
RF-3	50	150	20	10-12 mm
RF-4	50	150	25	14-16 mm
RF-5	50	150	32	18-25 mm



Torx-Schrauben für Platten (VN) Torx Screws for Inserts (VN)

Artikelnr. Code	Typ Type	Größe Size	Werkzeuge Tools
VN-1	TORX	M2,5x8	UT-02, UT-03, UT-04, UT-05
VN-2	TORX	M4x10	UT-06, UT-08
VN-3	TORX	M6x15	UT-10, UT-12, UT-14/16
VN-4	TCEI	M8x16	UT-18/25



Kugeldruckschraube (BU) Ball Pressure Screw (BU)

Artikelnr. Code	Größe Size	Länge (mm) Length (mm)
BU-1	M6x15	15
BU-2	M8x20	20
BU-3	M10x20	20
BU-4	M12x25	25
BU-5	M14x25	25
BU-6	M16x30	30

Artikelnr. Code	Größe Size	Länge (Zoll) Length (inch)
BU-7	UNC 5/16" - 18	37/64"
BU-8	UNC 3/8" - 16	5/8"
BU-9	UNV 1/2" - 13	3/4"
BU-10	UNC 5/8" - 11	36/64"

- Um Klemmhalter (UT) in den Bohrstangenhalter zu spannen auf Drehmaschinen.
- Hält Halter fest, beim verstellen mithilfe Exzenterbuchse.

- Used to clamp insert holders (UT) to boring bar holders on CNC lathes.
- Keeps holder in position when correcting alignment errors with eccentric bushing.



Torx-Schraubenzieher Torx Screwdriver

Artikelnr. Code	T	D
T-08	Torx	8
T-15	Torx	15
T-20	Torx	20

- ☑ Nutstoßaggregat zum Nuten, Vierkant, Sechskant und Verzahnungsprofile auf Drehmaschinen Stoßen
- ☑ Live Broaching Unit to Broach Keyways, Square, Hexagon and Spline Profiles on your Lathe

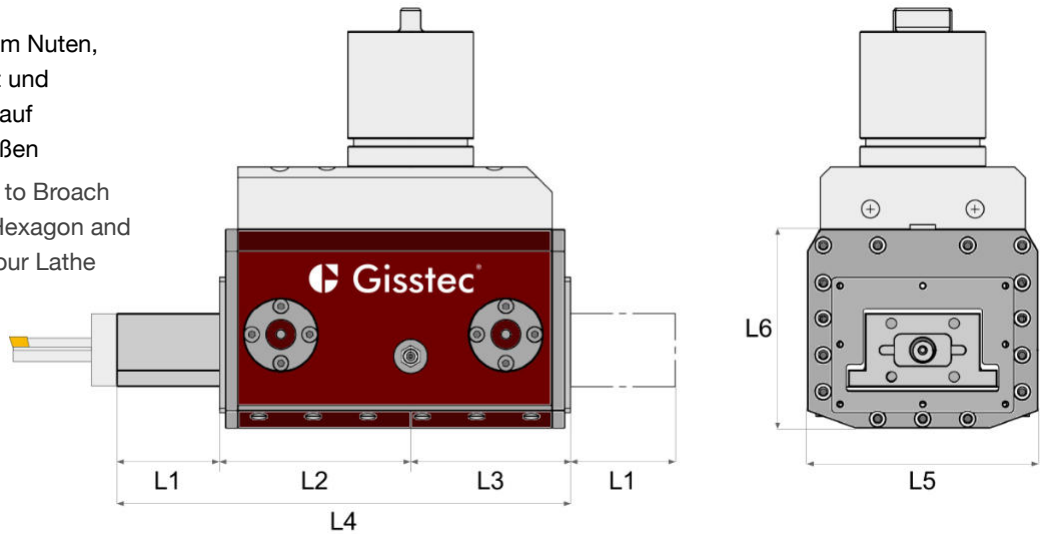

Artikelnr. Code	Hub Stroke	Hub (Zoll) Stroke (inch)	L1 mm	L2 mm	L3 mm	L4 mm	L5 mm	L6 mm
NG-27	25 mm	0.98"	27	50	48	125	63	52
NG-35	33 mm	1.29"	35	76,5	76	187,5	100	95
NG-50	48 mm	1.88"	50	90,5	76	216,5	110	95
NG-65	63 mm	2.48"	65	106,5	76,5	248	125	95

Radiale Schnittstelle Standard / Standard Radial Interface with shaft

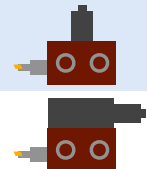

Axiale Schnittstelle / Axial Interface with angular transmission



- ☑ Perfekte Symmetrie: Y-Achsenverstellung $\pm 0,3$
- ☑ Parallelitätsverstellung auf Z-Achse ± 0.3
- ☑ Max. 1000 U/min
- ☑ 1 U/min = 1 Hub
- ☑ Innen- und Außenbearbeitung



- ☑ Perfect Symmetry: Y axis Adjustment ± 0.3
- ☑ Longitudinal Adjustment on Z axis ± 0.3
- ☑ Max. 1000 RPM
- ☑ 1 RPM = 1 Stroke
- ☑ Internal and External Operations



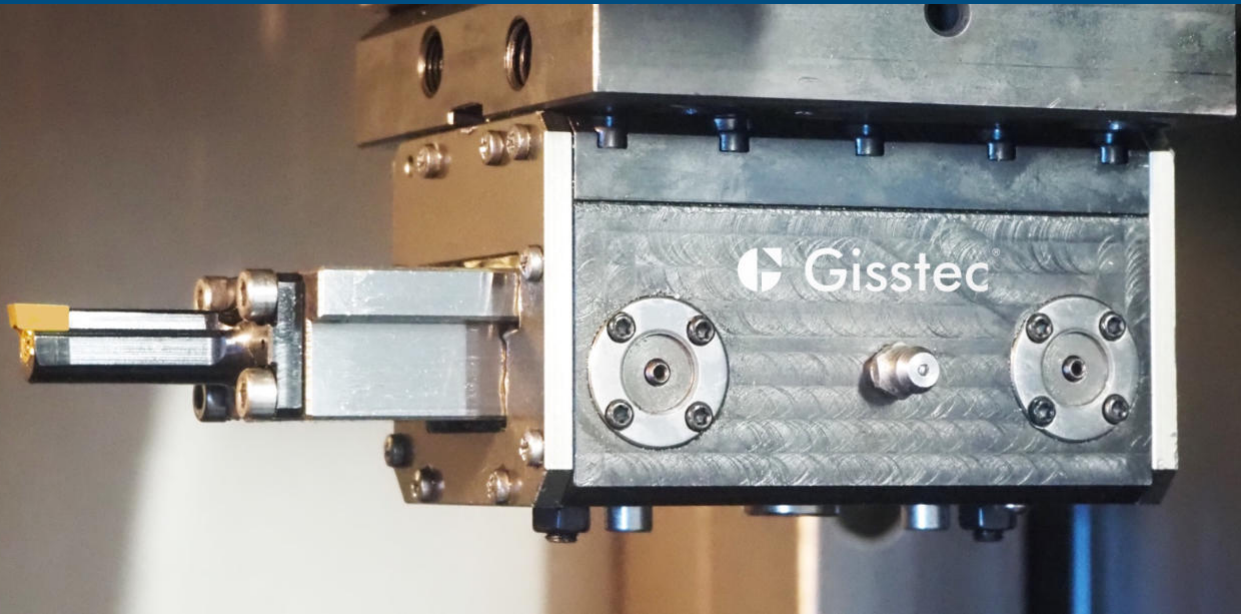

Material	Max. Nutenbreite / Max Keyway Width			Schnittgeschw. Cutting speed	Schnitttiefe Cutting Depth
	NG-35	NG-50	NG-65		
Aluminium Aluminium	16mm	16mm	16mm	38 m/min.	0,06 / 0,15 mm
Weichstahl Soft steel	14mm	14mm	14mm	33 m/min.	0,04 / 0,07 mm
Gusseisen Cast iron	14mm	14mm	12mm	28 m/min.	0,04 / 0,07 mm
Stahl Common steel	14mm	14mm	12mm	30 m/min.	0,03 / 0,05 mm
Gehärteter Stahl Hardened steel	12mm	12mm	10mm	25 m/min.	0,02 / 0,04 mm
Edelstahl Stainless steel	12mm	12mm	10mm	25 m/min.	0,02 / 0,04 mm
Kunststoff Plastic	18mm	18mm	18mm	40 m/min.	0,07 / 0,15 mm
Bronze, Messing Bronze, Brass	14mm	12mm	12mm	30 m/min.	0,03 / 0,06 mm

Max  37mm / 1,45"

Max  45mm / 1,77"

Wartung

- ☑ Alle 1.000 Betriebsstunden: Allgemeine Wartung, Verschleißteile ersetzen.

Maintenance

- ☑ Every 1000 hours of use: General maintenance, replace wearing parts.

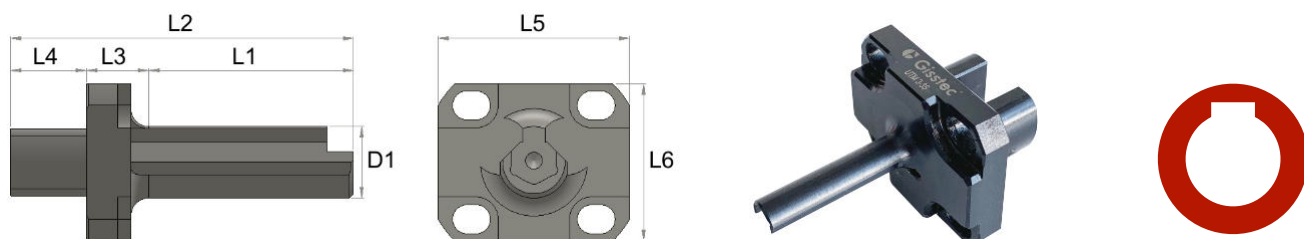

Artikelnr. Code	L1 mm	L2 mm	L3 mm	L4 mm	L5 mm	L6 mm	D1 mm	PN	T	VN	Min Ø mm
NG-27											
UTM-02-25	26	43	8	9	27,5	19	6,5	PN-0	T-08	VN-1	7
UTM-03-25	26	43	8	9	27,5	19	8	PN-1	T-08	VN-1	8,7
UTM-04-25	26	43	8	9	27,5	19	10	PN-1	T-08	VN-1	11
UTM-05-25	26	43	8	9	27,5	19	12	PN-1	T-08	VN-1	13
UTM-06-25	26	43	8	9	27,5	19	15	PN-2	T-15	VN-2	17
NG-35											
UTM-02-35	25	58	13	20	43	35	6	PN-0	T08	VN-1	7
UTM-03-35	30	63	13	20	43	35	8	PN-1	T08	VN-1	8,7
UTM-04-35	40	73	13	20	43	35	10	PN-1	T-08	VN-1	11
UTM-05-35	46	79	13	20	43	35	12	PN-1	T-08	VN-1	13
UTM-06-35	46	79	13	20	43	35	16	PN-2	T-15	VN-2	17
UTM-08-35	46	79	13	20	43	35	20	PN-2	T-15	VN-2	21,5
UTM-10/12-35	46	79	13	20	43	35	22	PN-3	T-20	VN-3	24
UTM-14/16-35	46	79	13	20	43	35	25	PN-4	T-20	VN-3	27
NG-50											
UTM-02-50	25	58	13	20	43	35	6	PN-0	T08	VN-1	7
UTM-03-50	30	63	13	20	43	35	8	PN-1	T08	VN-1	8,7
UTM-04-50	40	73	13	20	43	35	10	PN-1	T-08	VN-1	11
UTM-05-50	46	79	13	20	43	35	12	PN-1	T-08	VN-1	13
UTM-06-50	56	89	13	20	43	35	16	PN-2	T-15	VN-2	17
UTM-08-50	56	89	13	20	43	35	20	PN-2	T-15	VN-2	21,5
UTM-10/12-50	56	89	13	20	43	35	22	PN-3	T-20	VN-3	24
UTM-14/16-50	56	89	13	20	43	35	25	PN-4	T-20	VN-3	27
NG-65											
UTM-02-65	25	58	13	20	43	35	6	PN-0	T08	VN-1	7
UTM-03-65	30	63	13	20	43	35	8	PN-1	T08	VN-1	8,7
UTM-04-65	40	73	13	20	43	35	10	PN-1	T-08	VN-1	11
UTM-05-65	46	79	13	20	43	35	12	PN-1	T-08	VN-1	13
UTM-06-65	56	89	13	20	43	35	16	PN-2	T-15	VN-2	17
UTM-08-65	68	102	13	20	43	35	20	PN-2	T-15	VN-2	21,5
UTM-10/12-65	70	103	13	20	43	35	22	PN-3	T-20	VN-3	24
UTM-14/16-65	70	103	13	20	43	35	25	PN-4	T-20	VN-3	27

- * Bei Bestellung Marke/Modell des Nutstoßgerätes angeben
- * Specify Brand/Model of Live Broaching Tool with your order

Vierkant / Square

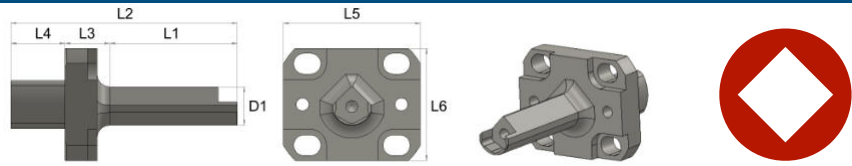

Artikelnr. Code	L1 mm	L2 mm	L3 mm	L4 mm	L5 mm	L6 mm	D1 mm	PN	T	VN	Min Ø mm
NG-27											
UTM-SQ-8/10-25	26	29	8	9	27,5	19	8	PN-1	T-08	VN-1	8,5
UTM-SQ-10/13-25	26	29	8	9	27,5	19	8,6	PN-1	T-08	VN-1	10
UTM-SQ-13/16-25	26	29	8	9	27,5	19	12	PN-2	T-15	VN-2	13
NG-35											
UTM-SQ-8/10-35	30	58	13	20	43	35	7,25	PN-1	T08	VN-1	8
UTM-SQ-10/13-35	40	63	13	20	43	35	8,6	PN-1	T08	VN-1	10
UTM-SQ-13/16-35	46	73	13	20	43	35	12	PN-2	T-15	VN-2	13
UTM-SQ-16/19-35	46	79	13	20	43	35	15	PN-3	T-20	VN-3	16
UTM-SQ-19/27-35	46	79	13	20	43	35	18,5	PN-3	T-20	VN-3	19
UTM-SQ-27/37-35	46	79	13	20	43	35	25	PN-4	T-20	VN-3	27
NG-50											
UTM-SQ-8/10-50	30	58	13	20	43	35	7,25	PN-1	T08	VN-1	8
UTM-SQ-10/13-50	40	63	13	20	43	35	8,6	PN-1	T08	VN-1	10
UTM-SQ-13/16-50	52	77	13	20	43	35	12	PN-2	T-15	VN-2	13
UTM-SQ-16/19-50	52	87	13	20	43	35	15	PN-3	T-20	VN-3	16
UTM-SQ-19/27-50	60	93	13	20	43	35	18,5	PN-3	T-20	VN-3	19
UTM-SQ-27/37-50	60	93	13	20	43	35	25	PN-4	T-20	VN-3	27
NG-65											
UTM-SQ-8/10-65	30	58	13	20	43	35	7,25	PN-1	T08	VN-1	8
UTM-SQ-10/13-65	40	63	13	20	43	35	8,6	PN-1	T08	VN-1	10
UTM-SQ-13/16-65	52	77	13	20	43	35	12	PN-2	T-15	VN-2	13
UTM-SQ-16/19-65	52	87	13	20	43	35	15	PN-3	T-20	VN-3	16
UTM-SQ-19/27-65	75	108	13	20	43	35	18,5	PN-3	T-20	VN-3	19
UTM-SQ-27/37-65	75	108	13	20	43	35	25	PN-4	T-20	VN-3	27

Sechskant / Hexagon

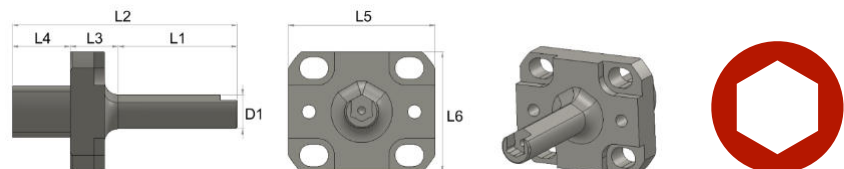

Artikelnr. Code	L1 mm	L2 mm	L3 mm	L4 mm	L5 mm	L6 mm	D1 mm	PN	T	VN	Min Ø mm
NG-27											
UTM-HEX-9/11-25	26	29	8	9	27,5	19	8	PN-1	T-08	VN-1	8,7
UTM-HEX-11/17-25	26	29	8	9	27,5	19	10	PN-1	T-08	VN-1	11,55
UTM-HEX-17/28-25	26	29	8	9	27,5	19	15	PN-2	T-15	VN-2	16
NG-35											
UTM-HEX-9/11-35	30	58	13	20	43	35	8	PN-1	T08	VN-1	8,7
UTM-HEX-11/17-35	40	63	13	20	43	35	10	PN-1	T08	VN-1	10
UTM-HEX-17/28-35	46	77	13	20	43	35	15	PN-2	T-15	VN-2	16
UTM-HEX-28/37-35	46	79	13	20	43	35	25	PN-3	T-20	VN-3	27
UTM-HEX-37/45-35	46	79	13	20	43	35	28	PN-4	T-20	VN-3	30
NG-50											
UTM-HEX-9/11-50	30	58	13	20	43	35	8	PN-1	T08	VN-1	8,7
UTM-HEX-11/17-50	40	63	13	20	43	35	10	PN-1	T08	VN-1	10
UTM-HEX-17/28-50	60	93	13	20	43	35	15	PN-2	T-15	VN-2	16
UTM-HEX-28/37-50	60	93	13	20	43	35	25	PN-3	T-20	VN-3	27
UTM-HEX-37/45-50	60	93	13	20	43	35	28	PN-4	T-20	VN-3	30
NG-65											
UTM-HEX-9/11-65	30	58	13	20	43	35	8	PN-1	T08	VN-1	8,7
UTM-HEX-11/17-65	40	63	13	20	43	35	10	PN-1	T08	VN-1	10
UTM-HEX-17/28-65	60	87	13	20	43	35	15	PN-2	T-15	VN-2	16
UTM-HEX-28/37-65	75	108	13	20	43	35	25	PN-3	T-20	VN-3	27
UTM-HEX-37/45-65	75	108	13	20	43	35	28	PN-4	T-20	VN-3	30

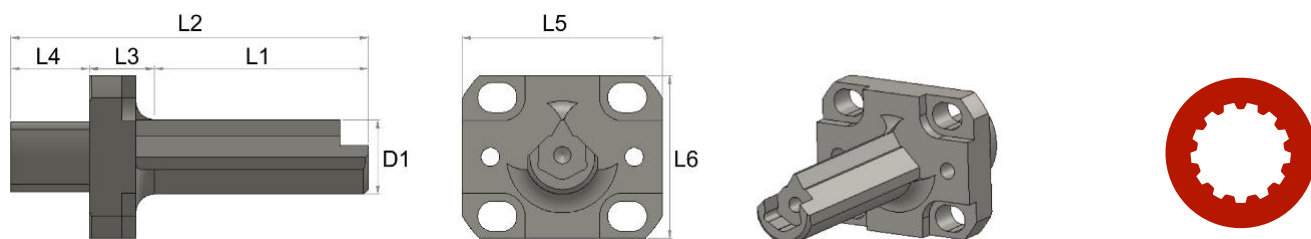

Artikelnr. Code	L1 mm	L2 mm	L3 mm	L4 mm	L5 mm	L6 mm	D1 mm	PN	T	VN	Min Ø mm
NG-27											
UTM-S-02-25	26	29	8	9	27,5	19	6,5	PN-0	T-08	VN-1	7
UTM-S-03-25	26	29	8	9	27,5	19	8	PN-1	T-08	VN-1	8,7
UTM-S-04-25	26	29	8	9	27,5	19	8	PN-1	T-08	VN-1	8,7
UTM-S-05-25	26	29	8	9	27,5	19	12	PN-1	T-08	VN-1	13
UTM-S-06-25	26	29	8	9	27,5	19	16	PN-2	T-15	VN-2	17
UTM-S-08-25	26	29	8	9	27,5	19	18	PN-2	T-15	VN-2	19,5
NG-35											
UTM-S-02-35	25	58	13	20	43	35	6,5	PN-0	T08	VN-1	7
UTM-S-03-35	30	63	13	20	43	35	8	PN-1	T08	VN-1	8,7
UTM-S-04-35	40	73	13	20	43	35	10	PN-1	T-08	VN-1	11
UTM-S-05-35	46	79	13	20	43	35	12	PN-1	T-08	VN-1	13
UTM-S-06-35	46	79	13	20	43	35	16	PN-2	T-15	VN-2	17
UTM-S-08-35	46	79	13	20	43	35	20	PN-2	T-15	VN-2	21,5
UTM-S-10-35	46	79	13	20	43	35	22	PN-3	T-20	VN-3	24
UTM-S-12-35	46	79	13	20	43	35	25	PN-3	T-20	VN-3	27
UTM-S-14/16-35	46	79	13	20	43	35	28	PN-4	T-20	VN-3	30
NG-50											
UTM-S-02-50	25	58	13	20	43	35	6,5	PN-0	T08	VN-1	7
UTM-S-03-50	30	63	13	20	43	35	8	PN-1	T08	VN-1	8,7
UTM-S-04-50	40	73	13	20	43	35	10	PN-1	T-08	VN-1	11
UTM-S-05-50	46	79	13	20	43	35	12	PN-1	T-08	VN-1	13
UTM-S-06-50	56	89	13	20	43	35	16	PN-2	T-15	VN-2	17
UTM-S-08-50	60	93	13	20	43	35	20	PN-2	T-15	VN-2	21,5
UTM-S-10-50	60	93	13	20	43	35	22	PN-3	T-20	VN-3	24
UTM-S-12-50	60	93	13	20	43	35	25	PN-3	T-20	VN-3	27
UTM-S-14/16-50	60	93	13	20	43	35	28	PN-4	T-20	VN-3	30
NG-65											
UTM-S-02-65	25	58	13	20	43	35	6,5	PN-0	T08	VN-1	7
UTM-S-03-65	30	63	13	20	43	35	8	PN-1	T08	VN-1	8,7
UTM-S-04-65	40	73	13	20	43	35	10	PN-1	T-08	VN-1	11
UTM-S-05-65	46	79	13	20	43	35	12	PN-1	T-08	VN-1	13
UTM-S-06-65	60	79	13	20	43	35	16	PN-2	T-15	VN-2	17
UTM-S-08-65	70	100	13	20	43	35	20	PN-2	T-15	VN-2	21,5
UTM-S-10-65	75	108	13	20	43	35	22	PN-3	T-20	VN-3	24
UTM-S-12-65	75	108	13	20	43	35	25	PN-3	T-20	VN-3	27
UTM-S-14/16-65	75	108	13	20	43	35	28	PN-4	T-20	VN-3	30

Mini-Klemmhalter für Nutstoßgeräte
 Mini Holder for Live Broaching Tools

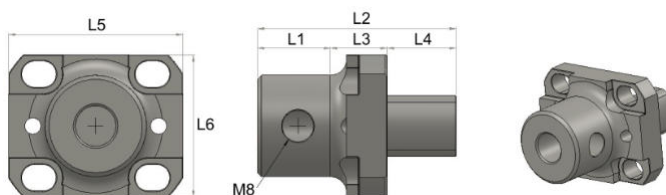

NG-27/NG-35/NG-50/NG-65	L1 mm	L2 mm	L3 mm	L4 mm	L5 mm	L6 mm
UTM-M	20	50	15	20	43	35

Klemmhalter für Nutstoßgeräte - Verzahnung Holders for Live Broaching Tools - Spline BENZ-EWS

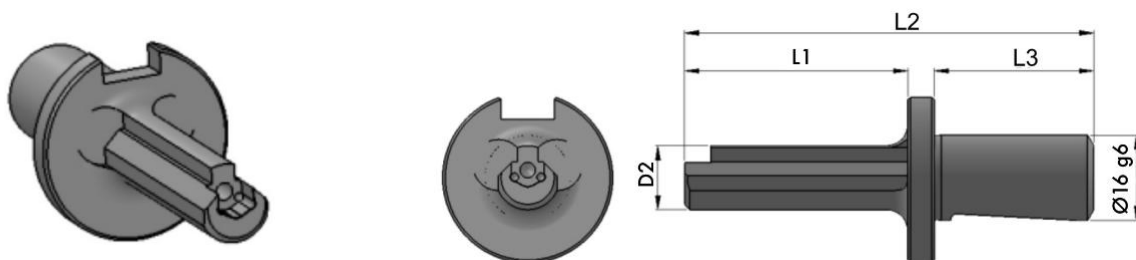

Artikelnr. Code	L1 mm	L2 mm	L3 mm	L4 mm	L5 mm	L6 mm	D1 mm	PN	T	VN	Min Ø mm
UTM-02	25	60	30	16 g6	6,5	7	7	RF-0	T-08	VN-1	7
UTM-03	30	65	30	16 g6	8	30	8,5	RF-1	T-08	VN-1	8,7
UTM-04	40	75	30	16 g6	11	30	10	RF-1	T-08	VN-1	11
UTM-05	46	81	30	16 g6	12	30	13	RF-1	T-08	VN-1	13
UTM-06	56	91	30	16 g6	16	30	17	RF-2	T-15	VN-2	17
UTM-08	60	95	30	16 g6	20	30	21	RF-2	T-15	VN-2	21,5
UTM-10	60	95	30	16 g6	22	30	24	RF-3	T-20	VN-3	24

Klemmhalter für Nutstoßgeräte - Verzahnung Holders for Live Broaching Tools - Spline PINTO

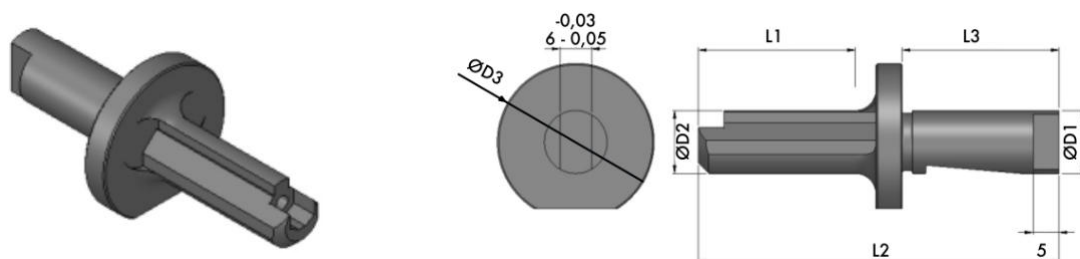

Artikelnr. Code	L1 mm	L2 mm	L3 mm	L4 mm	L5 mm	L6 mm	D1 mm	PN	T	VN	Min Ø mm
UTM-02	25	30	5	12 g6	6,5	25	7	RF-0	T-08	VN-1	7
UTM-03	30	30	5	12 g6	8	25	8,5	RF-1	T-08	VN-1	8,7
UTM-04	40	30	5	12 g6	11	25	10	RF-1	T-08	VN-1	11
UTM-05	46	30	5	12 g6	12	25	13	RF-1	T-08	VN-1	13
UTM-06	56	30	5	12 g6	16	25	17	RF-2	T-15	VN-2	17
UTM-08	60	30	5	12 g6	20	25	21	RF-2	T-15	VN-2	21,5
UTM-10	60	30	5	12 g6	22	25	24	RF-3	T-20	VN-3	24

Klemmhalter für Nutstoßgeräte - Verzahnung

Holder for Live Broaching Tools - Spline

MARCHETTI

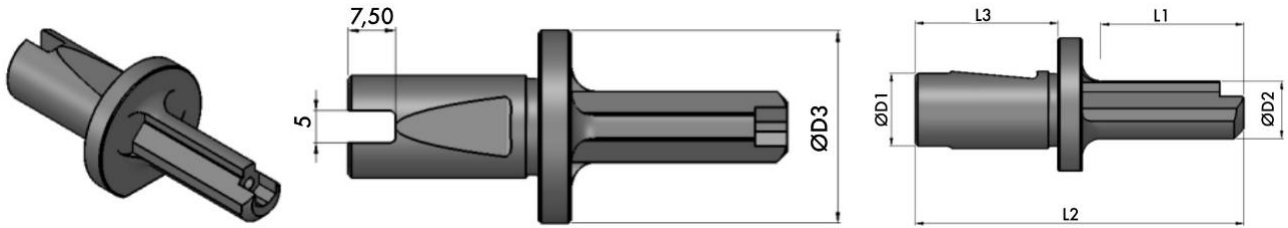

Artikelnr. Code	L1 mm	L2 mm	L3 mm	L4 mm	L5 mm	L6 mm	D1 mm	PN	T	VN	Min Ø mm
UTM-02	25	64	30	16 g6	6,5	16	7	RF-0	T-08	VN-1	7
UTM-03	30	69	30	16 g6	8	16	8,5	RF-1	T-08	VN-1	8,7
UTM-04	40	79	30	16 g6	11	16	10	RF-1	T-08	VN-1	11
UTM-05	46	85	30	16 g6	12	116	13	RF-1	T-08	VN-1	13
UTM-06	56	95	30	16 g6	16	25	17	RF-2	T-15	VN-2	17
UTM-08	60	99	30	16 g6	20	25	21	RF-2	T-15	VN-2	21,5
UTM-10	60	99	30	16 g6	22	25	24	RF-3	T-20	VN-3	24

Klemmhalter für Nutstoßgeräte - Verzahnung

Holder for Live Broaching Tools - Spline

WTO

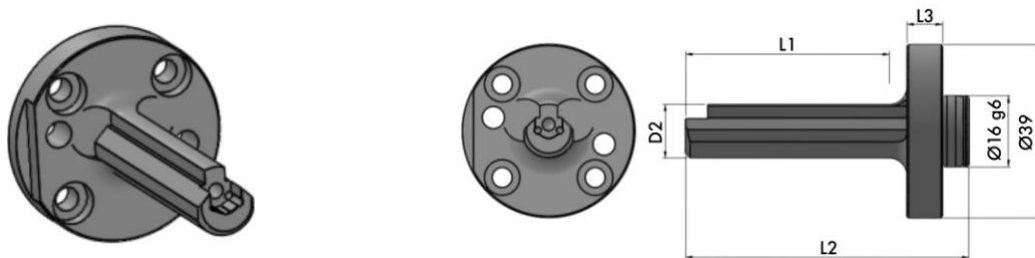

Artikelnr. Code	L1 mm	L2 mm	L3 mm	L4 mm	L5 mm	L6 mm	D1 mm	PN	T	VN	Min Ø mm
UTM-02	25	43	8	16 g6	6,5	39	7	RF-0	T-08	VN-1	7
UTM-03	30	48	8	16 g6	8	39	8,5	RF-1	T-08	VN-1	8,7
UTM-04	40	58	8	16 g6	11	39	10	RF-1	T-08	VN-1	11
UTM-05	46	64	8	16 g6	12	39	13	RF-1	T-08	VN-1	13
UTM-06	56	74	8	16 g6	16	39	17	RF-2	T-15	VN-2	17
UTM-08	60	78	8	16 g6	20	39	21	RF-2	T-15	VN-2	21,5
UTM-10	60	78	8	16 g6	22	39	24	RF-3	T-20	VN-3	24

Klemmhalter für Nutstoßgeräte - Verzahnung
 Holders for Live Broaching Tools - Spline
 SCHWARZER

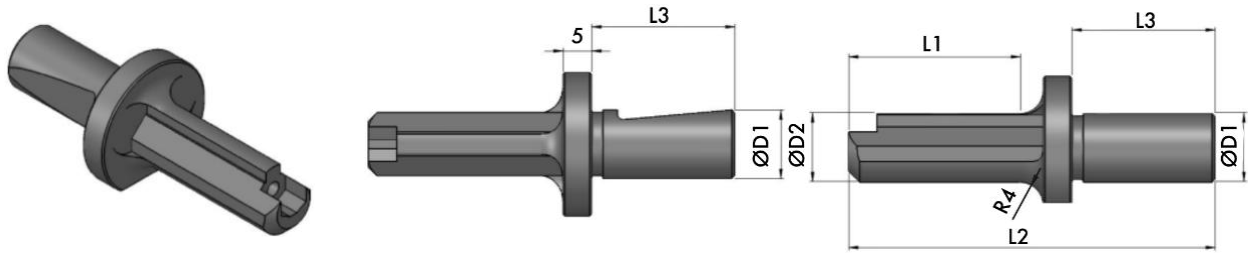

Artikelnr. Code	L1 mm	L2 mm	L3 mm	L4 mm	L5 mm	L6 mm	D1 mm	PN	T	VN	Min Ø mm
UTM-02	25	68	34	15 g6	6,5	25	7	RF-0	T-08	VN-1	7
UTM-03	30	73	34	15 g6	8	25	8,5	RF-1	T-08	VN-1	8,7
UTM-04	40	83	34	15 g6	11	25	11	RF-1	T-08	VN-1	11
UTM-05	46	89	34	15 g6	12	25	13	RF-1	T-08	VN-1	13
UTM-06	56	99	34	15 g6	16	25	17	RF-2	T-15	VN-2	17
UTM-08	60	103	34	15 g6	20	25	21	RF-2	T-15	VN-2	21,5
UTM-10	60	103	34	15 g6	22	25	24	RF-3	T-20	VN-3	24

Klemmhalter für Nutstoßgeräte - Verzahnung
 Holders for Live Broaching Tools - Spline
 SCHWARZER 2 IN 1

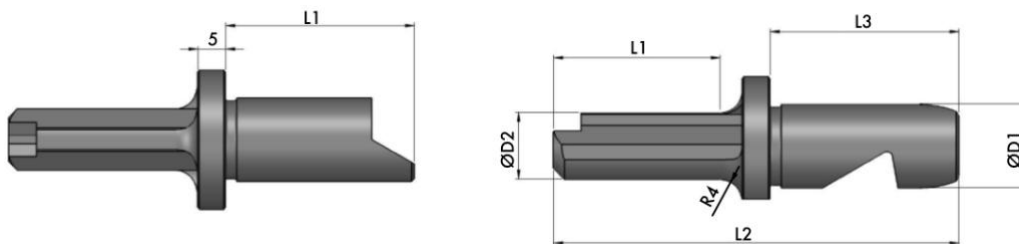

Artikelnr. Code	L1 mm	L2 mm	L3 mm	L4 mm	L5 mm	L6 mm	D1 mm	PN	T	VN	Min Ø mm
UTM-02	25	68	34	15 g6	6,5	25	7	RF-0	T-08	VN-1	7
UTM-03	30	73	34	15 g6	8	25	8,5	RF-1	T-08	VN-1	8,7
UTM-04	40	83	34	15 g6	11	25	11	RF-1	T-08	VN-1	11
UTM-05	46	89	34	15 g6	12	25	13	RF-1	T-08	VN-1	13
UTM-06	56	99	34	15 g6	16	25	17	RF-2	T-15	VN-2	17
UTM-08	60	103	34	15 g6	20	25	21	RF-2	T-15	VN-2	21,5
UTM-10	60	103	34	15 g6	22	25	24	RF-3	T-20	VN-3	24



KIT-625 KIT-632
KIT-625-L KIT-632-L

- ✓ UT-03, 04, 05, 06, 08, 10
- ✓ B32 / B40 / AD35 / AD40
- ✓ 12 Platten / Inserts
- ✓ RF-1, RF-2, RF-3
- ✓ 3 Schraubendreher / Screwdrivers
- ✓ Werkzeugständer / Tool carrier



KIT-725 KIT-732
KIT-725-L KIT-732-L

- ✓ UT-03, 04, 05, 06, 08, 10, 12
- ✓ B32 / B40 / AD35 / AD40
- ✓ 14 Platten / Inserts
- ✓ RF-1, RF-2, RF-3
- ✓ 3 Schraubendreher / Screwdrivers
- ✓ Werkzeugständer / Tool carrier



KIT-825 KIT-832
KIT-825-L KIT-832-L

- ✓ UT-03, 04, 05, 06, 08, 10, 12, 14/16
- ✓ B32 / B40 / AD35 / AD40
- ✓ 18 Platten / Inserts
- ✓ RF-1, RF-2, RF-3, RF-4
- ✓ 3 Schraubendreher / Screwdrivers
- ✓ Werkzeugständer / Tool carrier



Material	Schnittgeschw. Cutting Speed	Schnitttiefe (mm) Cutting Depth (mm)	Empfohlene Schnitttiefe (mm) Recommended Cutting Depth (mm)
Aluminium Aluminium	10 m/min	0,10 - 0,25	0,20
Weichstahl Soft steel	8 m/min	0,06 - 0,15	0,11
Gusseisen Cast iron	6 m/min	0,06 - 0,20	0,13
Stahl Common steel	6 m/min	0,04 - 0,12	0,08
Gehärteter Stahl Hardened steel	5 m/min	0,03 - 0,08	0,06
Edelstahl Stainless steel	5 m/min	0,03 - 0,08	0,06
Kunststoff Plastic	10 m/min	0,20 - 0,30	0,25
Bronze, Messing Bronze, Brass	7 m/min	0,05 - 0,15	0,10

- * Für Nuten mit einer Breite über 18 mm empfehlen wir eine Rohbearbeitung mit einer 12-mm-Platte im Vorfeld.
- * For keyways with a width of greater than 18 mm we recommend roughing with a 12 mm insert first.

Die Belastung auf der Maschinenspindel während einer Nutenstoßbearbeitung von 20 mm entspricht einer Bohrbearbeitung von Ø14 mm.

The load on the machine spindle during a broaching operation of 20 mm corresponds to a drilling operation of Ø14mm.

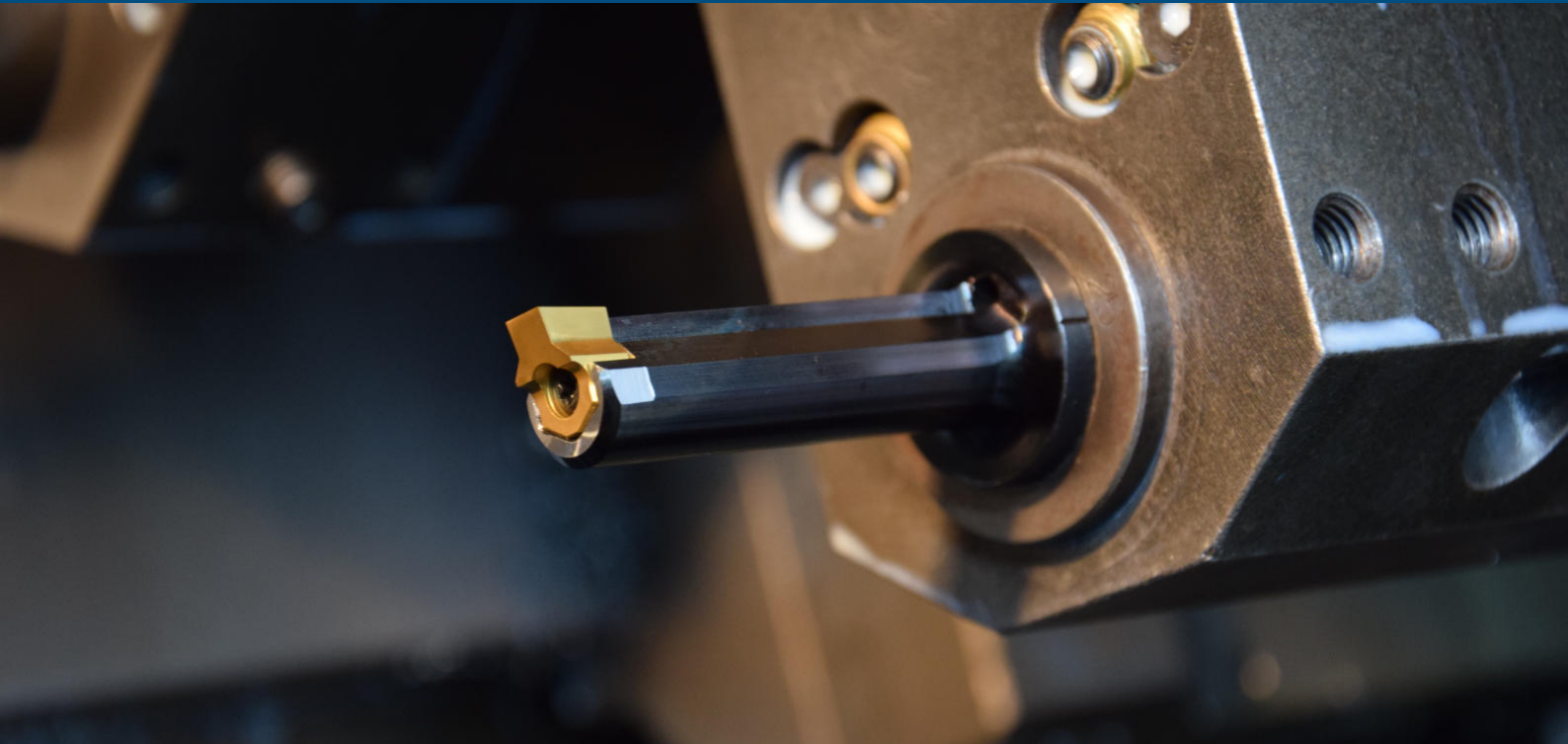

Gisstec GmbH

Ackerstr. 20
40233 Düsseldorf
Germany

☎ +49 211 2486 3666

📞 +49 163 448 7941

info@gisstec.com

www.gisstec.com

www.broachingtool.net